



SHAKTI PUMP

WINNERS OF GLOBAL TRUST



SUBMERSIBLE PUMPS

60 Hz CATALOG
NORTH AMERICA

Contents

Construction

Sectional drawing, QF Pump 4" spline shaft (QF 1- QF 6)..... Page 1
 Sectional drawing, QF Pump 4" smooth shaft (QF 12- QF 25)..... Page 2
 Sectional drawing, QF Pump 6" (QF 30- QF 100)..... Page 3
 Sectional drawing, QF Pump 8" (QF 125- QF 160)..... Page 4
 Sectional drawing, QF Pump 10" (QF 210- QF 360)..... Page 5

Performance Curve And Technical Data

4 Inch Submersibles Pumps

5 GPM (QF 1)..... Page 7
 10 GPM (QF 2).....Page 9
 16 GPM (QF 5).....Page 11
 25 GPM (QF 6)..... Page 13
 40 GPM (QF 12).....Page 15
 60 GPM (QF 20).....Page 17
 75 GPM (QF 25).....Page 19

6 Inch Submersibles Pumps

85 GPM (QF 30).....Page 21
 150 GPM (QF 50).....Page 22
 230 GPM (QF 75).....Page 25
 300 GPM (QF 100)..... Page 28
 310 GPM (QF 100)..... Page 31

8 Inch Submersibles Pumps

385 GPM (QF 125)..... Page 34
 475 GPM (QF 160)..... Page 37

10 Inch & above Submersibles Pumps

625 GPM (QF 210)..... Page 40
 800 GPM (QF 270)..... Page 43
 1100 GPM (QF 360)..... Page 46

Submersible Motors

1 x 230 V, Submersible motors Encapsulated..... Page 49
 3 x 230 V, Submersible motors Encapsulated.....Page 50
 3 x 460 V, Submersible motors Rewindable.....Page 51

4-inch Submersibles

Construction

Sectional drawing, QF pump 4" spline shaft (QF 1- QF 6)

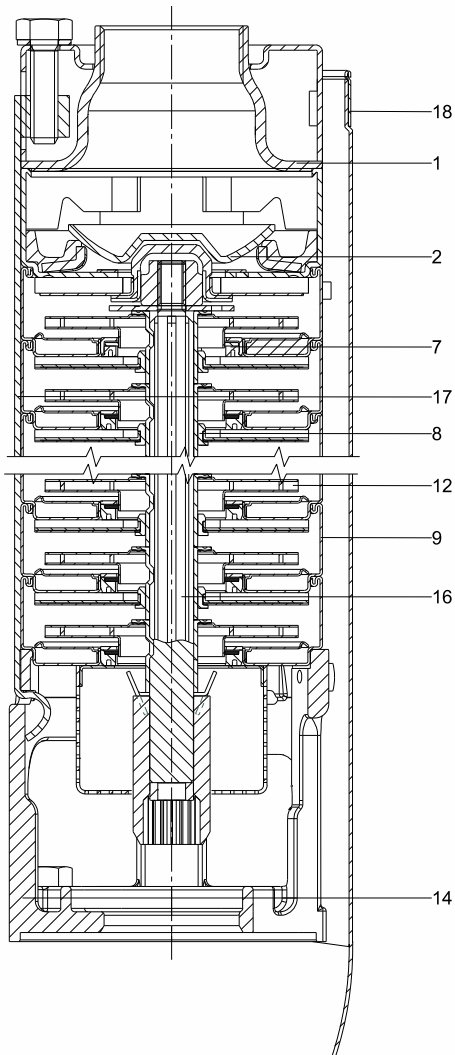

Material specification

Pos.	Component	Material	Standard	N-version
			[AISI (EN)]	
1	Valve casing	Stainless steel	304 (1.4301)	316 (1.4401)
2	Valve cup	Stainless steel	304 (1.4301)	316 (1.4401)
7	Neck ring	NBR/TPU		
8	Bearing	NBR		
9	Chamber	Stainless steel	304 (1.4301)	316 (1.4401)
12	Impeller	Stainless steel	304 (1.4301)	316 (1.4401)
14	Suction interconnector	Cast stainless steel	304 (1.4308)	316 (1.4408)
16	Shaft complete	Stainless steel	431 (1.4057)	329 (1.4460)
17	Strap	Stainless steel	304 (1.4301)	316 (1.4401)
18	Cable guard	Stainless steel	304 (1.4301)	316 (1.4401)
	Washer for stop ring	Carbon/graphite HY22 in PTFE mass		
	Strainer	Stainless steel	304 (1.4301)	316 (1.4401)
	Valve seat	Rubber type	NBR	NBR-FKM

Fig. 13 QF pump, 4" spline shaft (QF 1 - QF 6)

4-inch Submersibles

Sectional drawing, QF pump 4" smooth shaft (QF 12 - QF 25)

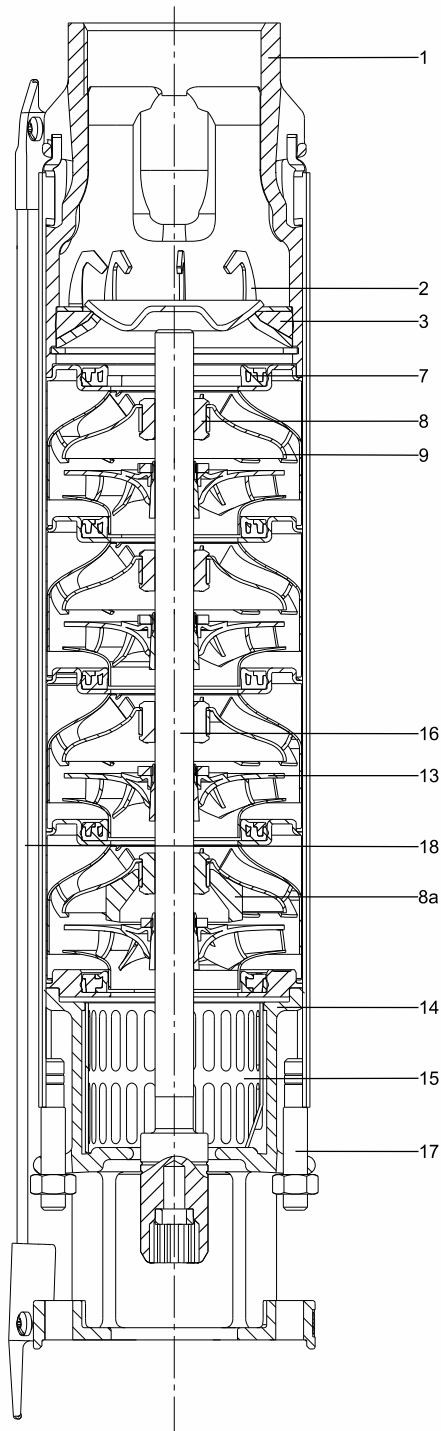

Material specification

Pos.	Component	Material	Standard	N-version
			[AISI (EN)]	
1	Valve casing	Cast stainless steel	304 (1.4301)	316 (1.4401)
2	Vabzap	Cast stainless steel	304 (1.4301)	316 (1.4401)
3	Valve seat	NBR-FKM	NBR-FKM	NBR-FKM
7	Neck ring	TPU/PPS-FKM	TPU/ PPS-FKM	TPU/ PPS-FKM
8	Bearing	LSR-FKM	LSR/FKM	LSR/FKM
8a	Washer for stop ring	Carbon/graphite HY22 in PTFE mass		
9	Chamber	Stainless steel	304 (1.4301)	316 (1.4401)
13	Impeller	Stainless steel	304 (1.4301)	316 (1.4401)
14	Suction interconnector	Cast stainless steel	304 (1.4308)	316 (1.4408)
16	Shaft complete	Stainless steel	1.4057	1.4460
17	Strap	Stainless steel	304 (1.4301)	316 (1.4401)
18	Cable guard	Stainless steel	304 (1.4301)	316 (1.4401)
	Strainer	Stainless steel	304 (1.4301)	316 (1.4401)

Fig. 14 QF pump, 4" smooth shaft (QF 12 - QF 25)

4-inch Submersibles

Sectional drawing, QF pump 6" smooth shaft (QF 30 - QF 100)

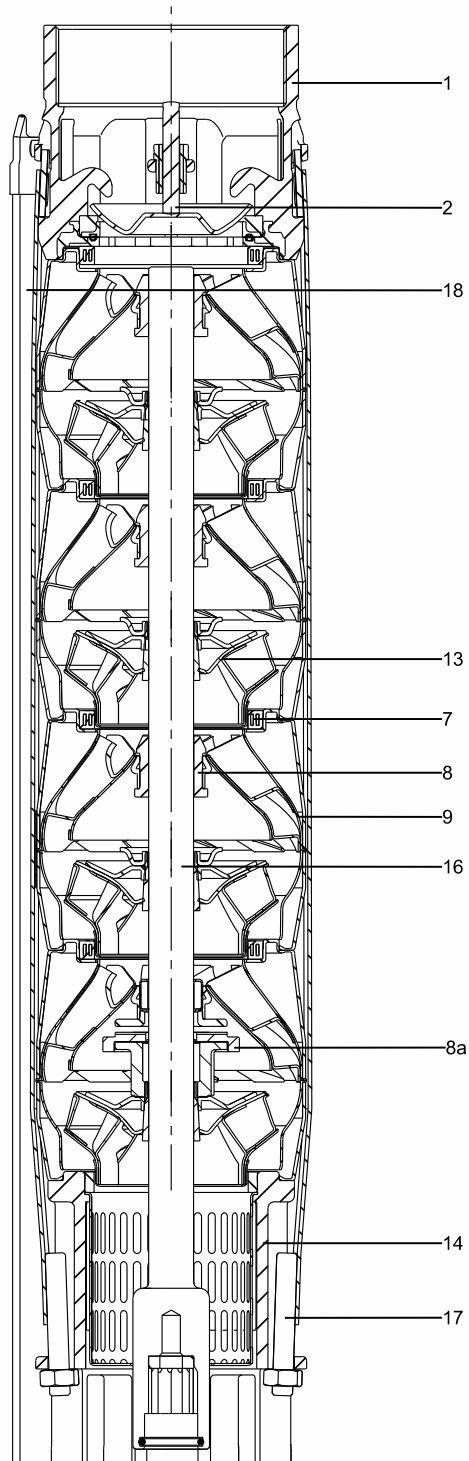

Material specification

Pos.	Component	Material	Standard	N-version
			[AISI (EN)]	
1	Valve casing	Stainless steel	304 (1.4301)	316 (1.4401)
2	Valve cup	Stainless steel	304 (1.4301)	316 (1.4401)
	Valve seat	NBR-FKM	NBR-FKM	NBR-FKM
7	Neck ring	NBR-FKM	NBR-FKM	NBR-FKM
8	Bearing	NBR-FKM-LSR	NBR-FKM-LSR	NBR-FKM-LSR
	Washer for stop ring	Carbon/graphite HY22 in PTFE mass		
9	Chamber	Stainless steel	304 (1.4301)	316 (1.4401)
13	Impeller	Stainless steel	304 (1.4301)	316 (1.4401)
14	Suction interconnector	Cast stainless steel	304 (1.4308)	316 (1.4408)
	Strainer	Stainless steel	304 (1.4301)	316 (1.4401)
16	Shaft complete	Stainless steel	431 (1.4057)	329 (1.4460)
17	Strap	Stainless steel	304 (1.4301)	316 (1.4401)
18	Cable guard	Stainless steel	304 (1.4301)	316 (1.4401)

Fig. 15 Example, 6" (QF 30 - QF 100)

4-inch Submersibles

Sectional drawing, QF pump 8" smooth shaft (QF 125 - QF 160)

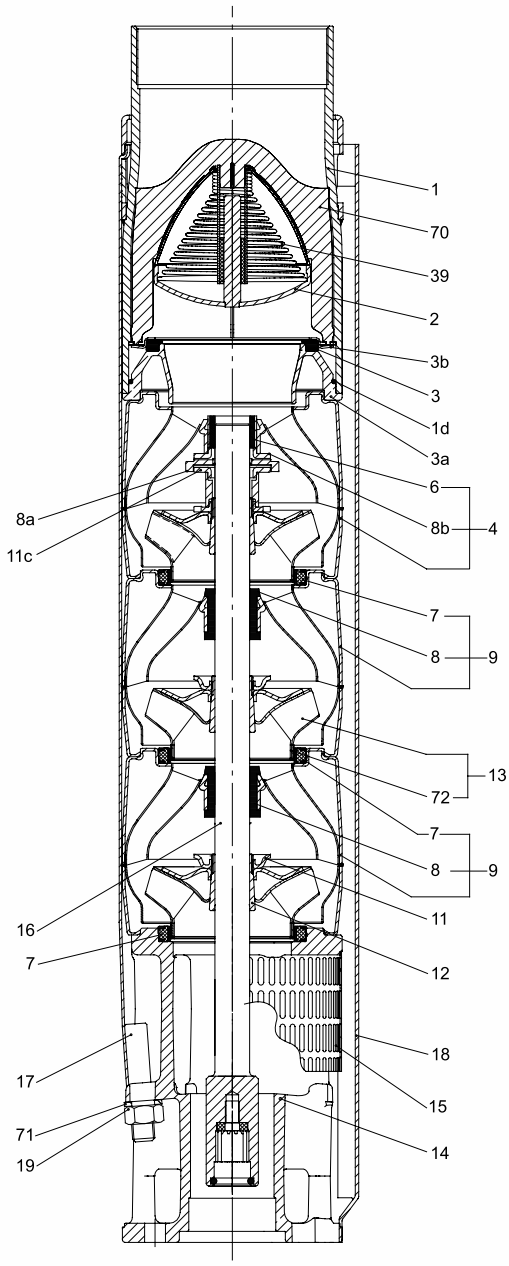

Material specification

Pos.	Component	Materials	Standard	N	R
			[AISI (EN)]		
1	Valve casing	Stainless steel	304 (1.4301)	316 (1.4401)	904L (1.4539)
1d	O-ring	NBR			
2	Valve cup	Stainless steel	304 (1.4301)	316 (1.4401)	904L (1.4539)
3	Valve seat	Standard/ N- version: NBR R- version: FKM			
3a	Lower valve seat retainer	Stainless steel	316 (1.4401)	316 (1.4401)	904L (1.4517)
3b	Upper valve seat retainer	Stainless steel	304 (1.4301)	316 (1.4401)	904L (1.4539)
4	Top chamber	Stainless steel	304 (1.4301)	316 (1.4401)	904L (1.4539)
6	Upper bearing	Stainless steel/NBR	304 (1.4301)	316 (1.4401)	904L (1.4539)
7	Neck ring	NBR/PPS			
8	Bearing	NBR			
8a	Washer for stop ring	Carbon/ graphite HY22 in PTFE mass			
8b	Stop ring	Stainless steel	316 (1.4401)	316 (1.4401)	904L (1.4539)
9	Chamber	Stainless steel	304 (1.4301)	316 (1.4401)	904L (1.4539)
11	Split cone nut	Stainless steel	304 (1.4301)	316 (1.4401)	904L (1.4539)
11c	Nut for stop ring	Stainless steel	316 (1.4401)	316 (1.4401)	904L (1.4539)
12	Split cone	Stainless steel	304 (1.4301)	316 (1.4401)	904L (1.4539)
13	Impeller	Stainless steel	304 (1.4301)	316 (1.4401)	904L (1.4539)
14	Suction interconnector	Stainless steel	CF8M	A744 CD4-MCu	904L (1.4517)
15	Strainer	Stainless steel	304 (1.4301)	316 (1.4401)	904L (1.4539)
16	Shaft complete	Stainless steel	431 (1.4057)	329 (1.4460)	329 (1.4460)
17	Strap	Stainless steel	304 (1.4301)	316 (1.4401)	904L (1.4539)
18	Cable guard	Stainless steel	304 (1.4301)	316 (1.4401)	904L (1.4539)
19	Nut for strap	Stainless steel	304 (1.4301)	316 (1.4401)	904L (1.4539)
39	Spring for valve cup	Stainless steel	304 (1.4301)	316 (1.4401)	SAF 2205
70	Valve guide	Stainless steel	304 (1.4301)	316 (1.4401)	904L (1.4539)
71	Washer	Stainless steel	316 (1.4401)	316 (1.4401)	904L (1.4539)
72	Wear ring	Stainless steel	304 (1.4301)	316 (1.4401)	904L (1.4539)

Fig. 16 QF pump, 8" (QF 125 - QF 160)

4-inch Submersibles

Sectional drawing, QF pump 10" smooth shaft (QF 210 - QF 360)

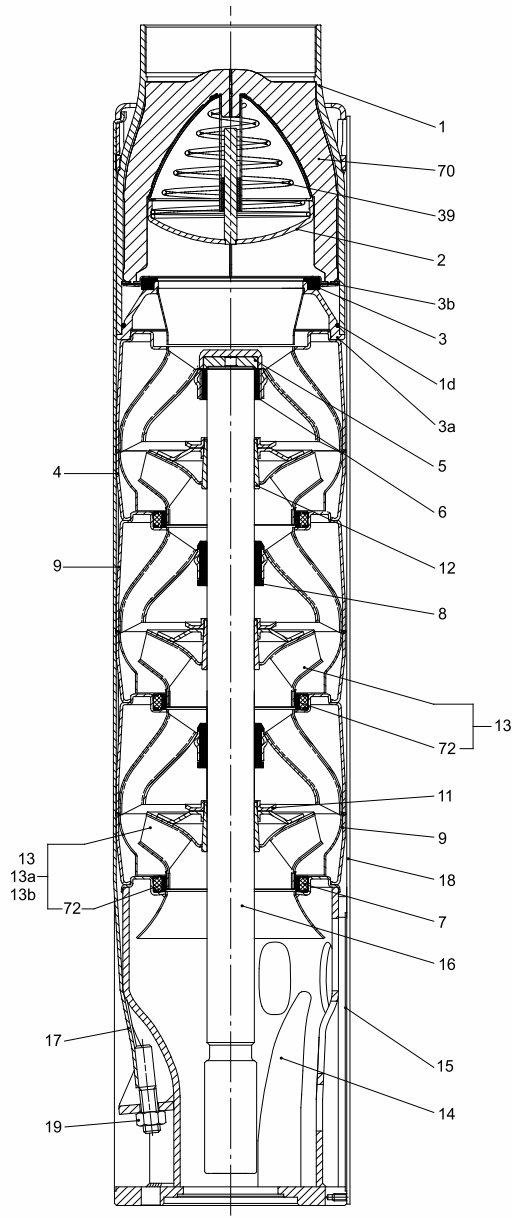

Fig. 17 QF pump, 10" (QF 210 - QF 360)

Material specification

Pos.	Description	Material	Standard	N
			version	
[AISI (EN)]				
Valve casing				
1	Valve casing	Stainless steel	304 (1.4301)	316 (1.4401)
1d	O-ring	NBR		
2	Valve cup	Stainless steel	304 (1.4301)	316 (1.4401)
3	Valve seat	Stainless steel	304 (1.4301)	316 (1.4401)
3a	Lower valve seat retainer	Stainless steel	304 (1.4301)	316 (1.4401)
3b	Upper valve seat retainer	Stainless steel	304 (1.4301)	316 (1.4401)
39	Spring for valve cup	Stainless steel	301 (1.4310)	316 (1.4401)
70	Valve guide	Stainless steel	304 (1.4301)	316 (1.4401)
78	Nameplate	Stainless steel	304 (1.4301)	316 (1.4401)
79	Rivet	Stainless steel	304 (1.4301)	316 (1.4401)
63	Connecting piece	Stainless steel	304 (1.4301)	316 (1.4401)
Chamber stack				
4	Top chamber	Stainless steel	304 (1.4301)	316 (1.4401)
5	Upthrust disc	Carbon/ graphite HY22 in PTFE mass		
6	Top bearing	Stainless steel/ NBR	304 (1.4301)	316 (1.4401)
7	Neck ring	NBR/PPS		
8	Bearing	NBR		
9	Chamber	Stainless steel	304 (1.4301)	316 (1.4401)
11	Nut for split cone	Stainless steel	304 (1.4301)	316 (1.4401)
12	Split cone	Stainless steel	304 (1.4301)	316 (1.4401)
13	Impeller	Stainless steel	304 (1.4301)	316 (1.4401)
16	Shaft with coupling	Stainless steel	431 (1.4057)	329 (1.4460)
18	Cable guard	Stainless steel	304 (1.4301)	316 (1.4401)
18a, 18b	Screw for cable guard	Stainless steel	304 (1.4301)	316 (1.4401)
23	Rubber guard	NBR		
72	Wear ring	Stainless steel	304 (1.4301)	316 (1.4401)
Suction interconnector				
14	Suction interconnector	Stainless steel	304 (1.4301)	316 (1.4401)
15	Strainer	Stainless steel	304 (1.4301)	316 (1.4401)
17	Strap	Stainless steel	304 (1.4301)	316 (1.4401)
19	Nut for strap	Stainless steel	304 (1.4301)	316 (1.4401)
19a	Nut	Stainless steel	316 (1.4401)	316 (1.4401)
20	Motor cable			
22	Bolts	Stainless steel	316 (1.4401)	316 (1.4401)
28, 28a	Lock for strainer	Stainless steel	329 (1.4460)	329 (1.4460)

Performance Curve And Technical Data

4-inch Submersibles



PERFORMANCE CURVE

5 GPM

MODEL QF 1

FLOW RANGE: 1-6 GPM

OUTLET SIZE: 1.25" NPT

NOMINAL DIA. 4"

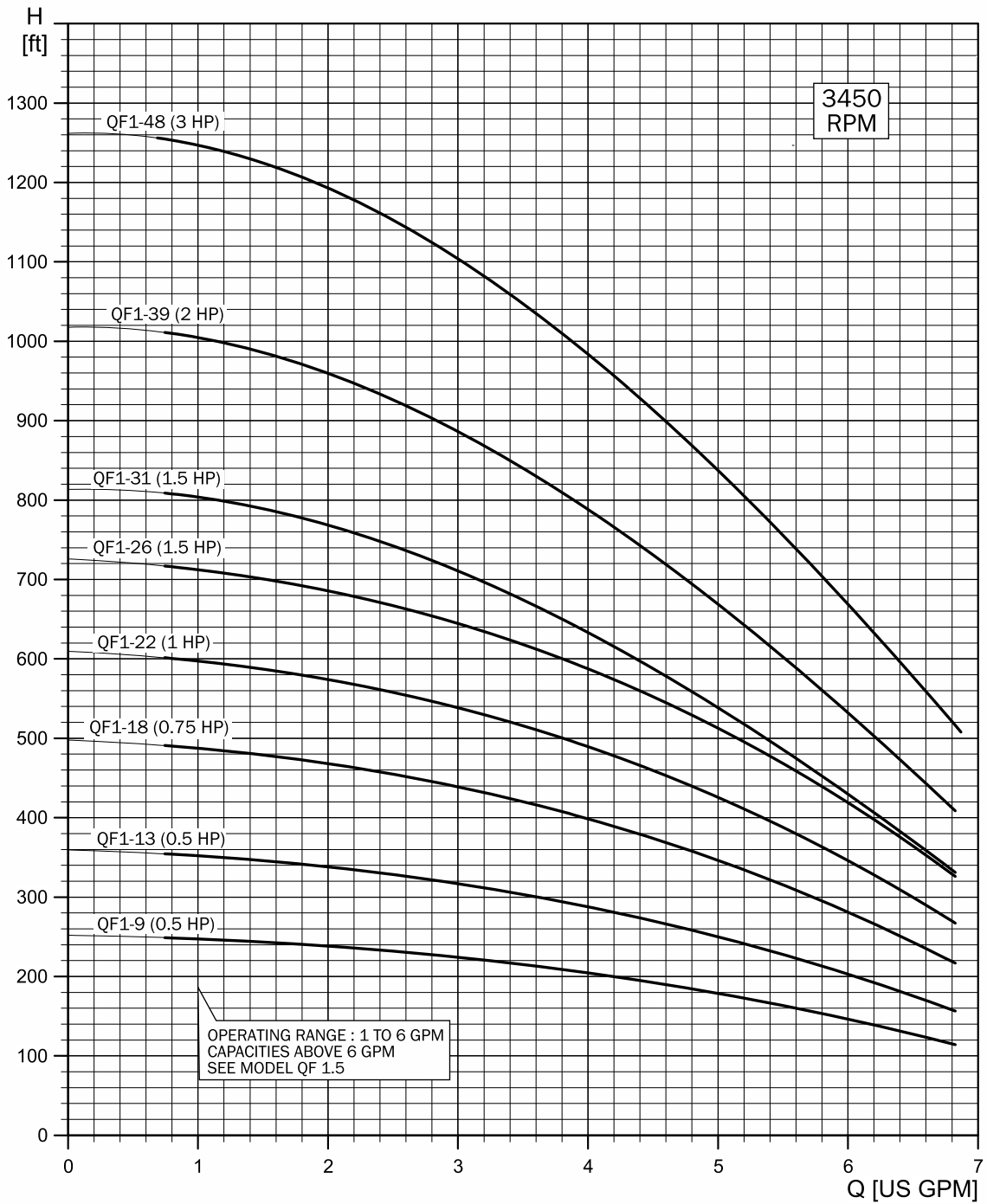

Performance conforms to ISO 9906 Annex A @ 2 ft. min. submergence.

TECHNICAL DATA

5 GPM

MODEL QF 1

2 WIRE

DIMENSIONS AND WEIGHTS

MODEL NO.	FIG.	HP	MOTOR SIZE	Ph	DISCH. SIZE	DIMENSIONS IN INCHES					APPROX SHIPPING WEIGHT (lbs)	
						A	B	C	D	E	PUMP	MOTOR
QF1-9	A	0.5	4"	1	1.25" NPT	24.2	9.5	14.7	3.7	4.0	13	22
QF1-13	A	0.5	4"	1	1.25" NPT	27.6	9.5	18.1	3.7	4.0	15	22
QF1-18	A	0.75	4"	1	1.25" NPT	33.9	10.7	22.4	3.7	4.0	18	24
QF1-22	A	1	4"	1	1.25" NPT	37.2	11.5	25.8	3.7	4.0	21	26
QF1-26	A	1.5	4"	1	1.25" NPT	43.9	14.7	29.2	3.7	4.0	23	35
QF1-31	A	1.5	4"	1	1.25" NPT	48.1	14.7	33.4	3.7	4.0	26	35

NOTES: All models suitable for use in 4" wells.

3 WIRE

MODEL NO.	FIG.	HP	MOTOR SIZE	Ph	DISCH. SIZE	DIMENSIONS IN INCHES					APPROX SHIPPING WEIGHT (lbs)	
						A	B	C	D	E	PUMP	MOTOR
QF1-9	A	0.5	4"	1	1.25" NPT	24.2	9.5	14.7	3.7	4.0	13	22
				3		25.4	10.7			24		
QF1-13	A	0.5	4"	1	1.25" NPT	24.2	9.5	18.1	3.7	4.0	15	22
				3		25.4	10.7			24		
QF1-18	A	0.75	4"	1	1.25" NPT	33.9	11.5	22.4	3.7	4.0	18	24
				3		33.1	10.7			24		
QF1-22	A	1	4"	1	1.25" NPT	37.2	11.5	25.8	3.7	4.0	21	26
				3		37.2	11.5			26		
QF1-26	A	1.5	4"	1	1.25" NPT	42.5	13.3	29.2	3.7	4.0	23	33
				3		42.5	13.3			33		
QF1-31	A	1.5	4"	1	1.25" NPT	46.8	13.3	33.4	3.7	4.0	26	33
				3		46.8	13.3			33		
QF1-39	B	2	4"	1	1.25" NPT	69.9	15.9	54.0	3.7	4.0	31	37
				3		69.9	15.9			37		
QF1-48	B	3	4"	1	1.25" NPT	84.5	21.2	63.4	3.7	4.0	36	53
				3		84.5	21.2			53		

NOTES: All models suitable for use in 4" wells.

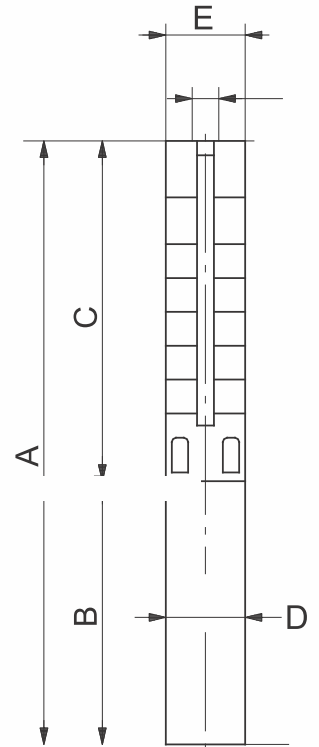

Fig. A

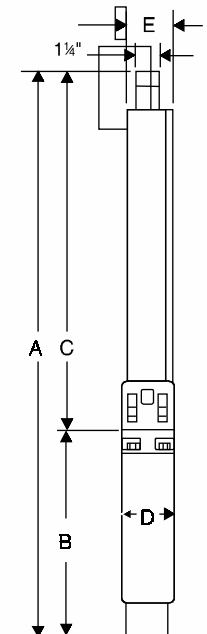

Fig. B

PERFORMANCE CURVE

10 GPM

MODEL QF 2

FLOW RANGE: 5 -14 GPM

OUTLET SIZE: 1 1/4" NPT

NOMINAL DIA. 4"

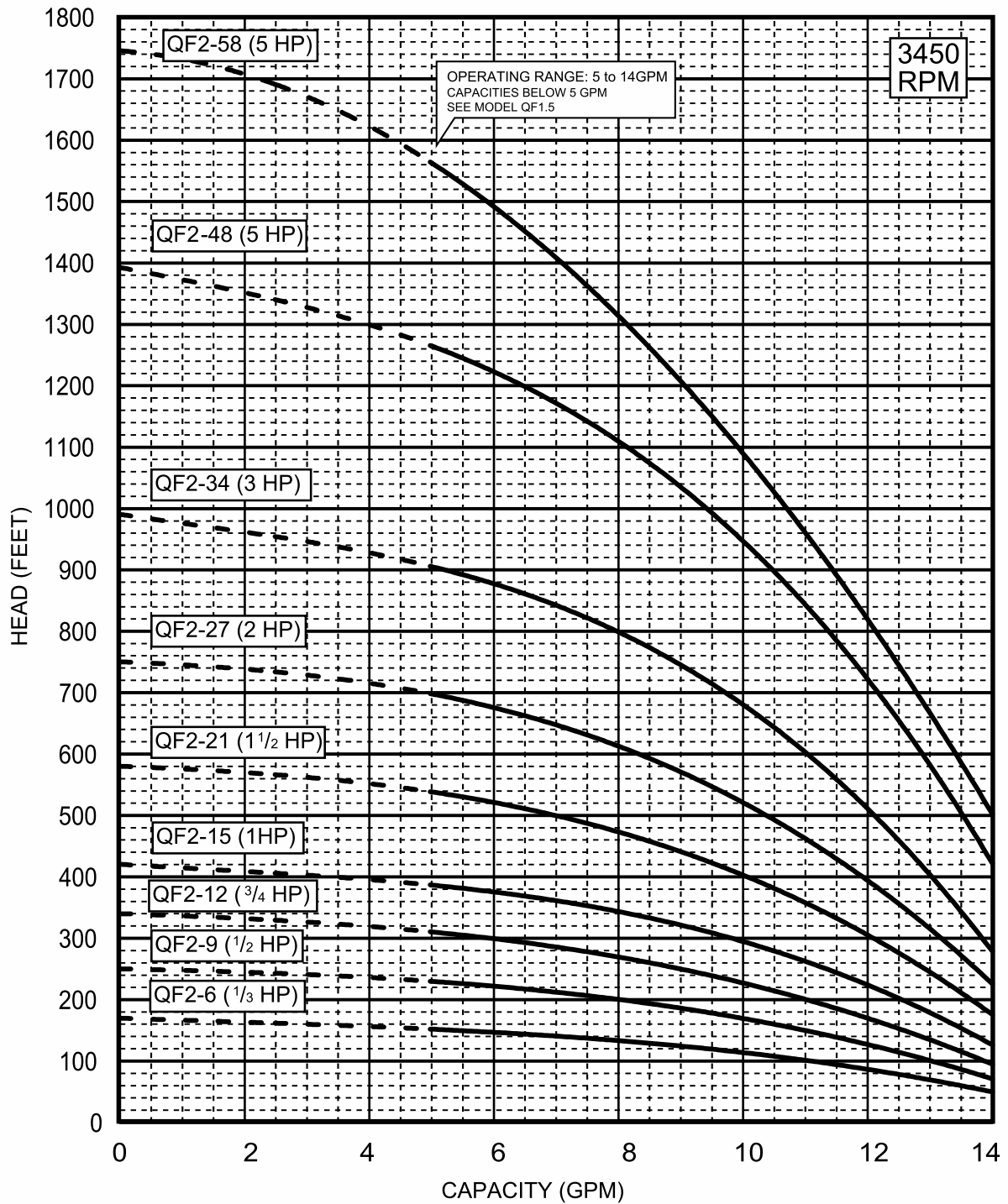

SPECIFICATIONS SUBJECT TO CHANGE WITHOUT NOTICE.
4" MOTOR STANDARD, 3450 RPM.

Performance conforms to ISO 9906 annex A
@ 2 ft. min. submergence.

TECHNICAL DATA

10 GPM

MODEL QF 2

2 WIRE

DIMENSIONS AND WEIGHTS

MODEL NO.	FIG.	HP	MOTOR SIZE	Ph	DISCH. SIZE	DIMENSIONS IN INCHES					APPROX SHIPPING WEIGHT (lbs)	
						A	B	C	D	E	PUMP	MOTOR
QF2 - 6	A	0.5	4"	1	1 1/4" NPT	23.9	9.5	14.4	3.8	3.9	12	22
QF2 - 9	A	0.5	4"	1	1 1/4" NPT	26.4	9.5	16.9	3.8	3.9	14	22
QF2 - 12	A	0.8	4"	1	1 1/4" NPT	30.0	10.7	19.4	3.8	3.9	15	24
QF2 - 15	A	1	4"	1	1 1/4" NPT	33.3	11.5	21.9	3.8	3.9	17	26
QF2 - 21	A	1.5	4"	1	1 1/4" NPT	41.6	14.8	26.8	3.8	3.9	21	35

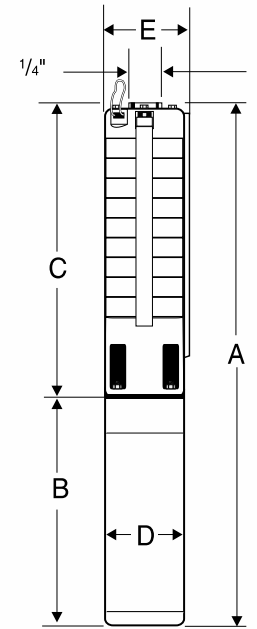

Fig. A

3 WIRE

MODEL NO.	FIG.	HP	MOTOR SIZE	Ph	DISCH. SIZE	DIMENSIONS IN INCHES					APPROX SHIPPING WEIGHT (lbs)	
						A	B	C	D	E	PUMP	MOTOR
QF2 - 6	A	0.5	4"	1/3	1 1/4" NPT	23.9	9.5	14.4	3.8	3.9	12	22
						25.1	10.7					24
QF2 - 9	A	0.5	4"	1/3	1 1/4" NPT	26.4	9.5	16.9	3.8	3.9	14	22
						27.5	10.7					24
QF2 - 12	A	0.8	4"	1/3	1 1/4" NPT	30.8	11.5	19.4	3.8	3.9	15	24
						30.0	10.7					24
QF2 - 15	A	1	4"	1/3	1 1/4" NPT	33.3	11.5	21.9	3.8	3.9	17	26
						31.2	11.5					26
QF2 - 21	A	1.5	4"	1/3	1 1/4" NPT	40.2	13.3	26.8	3.8	3.9	21	33
						40.2	13.3					33
QF2 - 27	A	2	4"	1/3	1 1/4" NPT	47.7	15.9	31.8	3.8	3.9	24	37
						47.7	15.9					37
QF2 - 34	A	3	4"	1/3	1 1/4" NPT	58.7	21.2	37.6	3.8	3.9	28	53
						58.7	21.2					53
QF2 - 48	A	5	4"	1/3	1 1/4" NPT	76.3	27.2	49.1	3.8	3.9	37	68
						71.9	22.8					57
QF2 - 58*	B	5	4"	1/3	1 1/4" MPT	84.6	27.2	57.4	3.8	4.3	43	68
						80.2	22.8					57

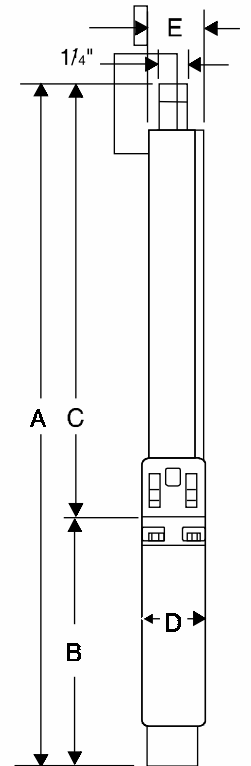

Fig. B

NOTES: All models suitable for use in 4" wells, unless otherwise noted.

* Built into sleeve 1 1/4" MPT discharge, 5" min. well dia.

PERFORMANCE CURVE

16 GPM

MODEL QF 5

FLOW RANGE: 10 -20 GPM

OUTLET SIZE: 1 1/4 " NPT

NOMINAL DIA. 4"

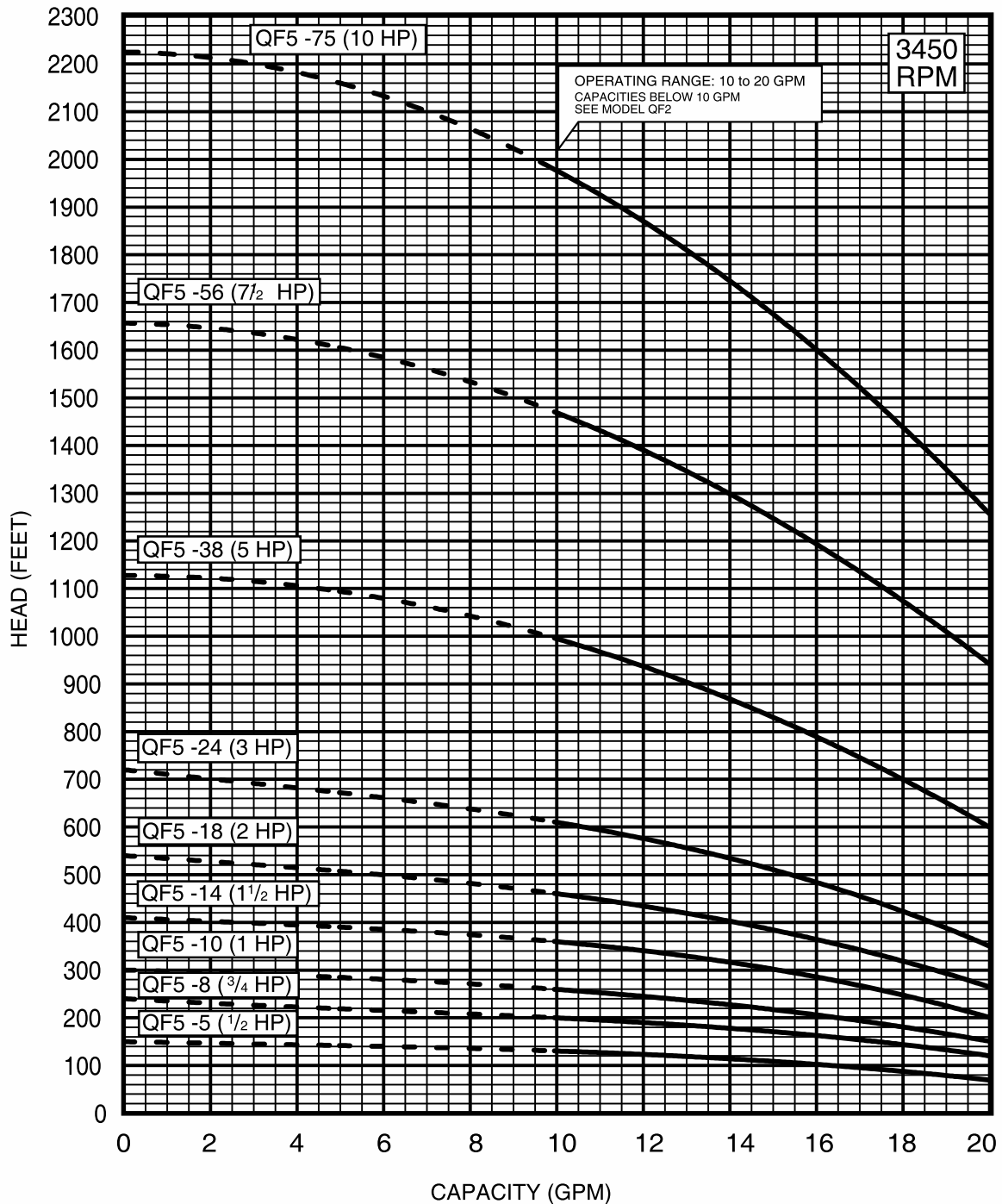

SPECIFICATIONS SUBJECT TO CHANGE WITHOUT NOTICE.
4" MOTOR STANDARD, .5-5 HP/3450 RPM.
6" MOTOR STANDARD, 7.5-10HP/3450 RPM.

Performance conforms to ISO 9906 Annex A
@ 2 ft. min. submergence.

TECHNICAL DATA

16 GPM

MODEL QF 5

2 WIRE

DIMENSIONS AND WEIGHTS

MODEL NO.	FIG.	HP	MOTOR SIZE	Ph	DISCH. SIZE	DIMENSIONS IN INCHES					APPROX SHIPPING WEIGHT (lbs)	
						A	B	C	D	E	PUMP	MOTOR
QF-5-5	A	0.5	4"	1	1 1/4" NPT	23.4	9.5	13.9	3.8	3.9	8	22
QF-5-8	A	0.75	4"	1	1 1/4" NPT	27.0	10.7	16.3	3.8	3.9	10	24
QF-5-10	A	1	4"	1	1 1/4" NPT	29.4	11.5	17.9	3.8	3.9	12	26
QF-5-14	A	1.5	4"	1	1 1/4" NPT	35.6	14.5	21.2	3.8	3.9	15	35

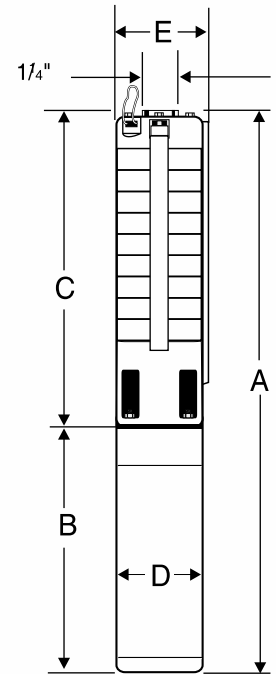

Fig. A

3 WIRE

MODEL NO.	FIG.	HP	MOTOR SIZE	Ph	DISCH. SIZE	DIMENSIONS IN INCHES					APPROX SHIPPING WEIGHT (lbs)	
						A	B	C	D	E	PUMP	MOTOR
QF-5-5	A	0.5	4"	1	1 1/4" NPT	23.4	9.5	13.9	3.8	3.9	8	22
				3		24.5	10.7					24
QF-5-8	A	0.75	4"	1	1 1/4" NPT	27.8	11.5	16.3	3.8	3.9	10	24
				3		27.0	10.7					24
QF-5-10	A	1	4"	1	1 1/4" NPT	29.4	11.5	17.9	3.8	3.9	12	26
				3		27.4	11.5					26
QF-5-14	A	1.5	4"	1	1 1/4" NPT	34.5	13.3	21.2	3.8	3.9	15	33
				3		34.5	13.3					33
QF-5-18	A	2	4"	1	1 1/4" NPT	40.3	15.9	24.4	3.8	3.9	17	37
				3		40.3	15.9					37
QF-5-24	A	3	4"	1	1 1/4" NPT	50.5	21.2	29.3	3.8	3.9	22	53
				3		50.5	21.2					53
QF-5-38	A	5	4"	1	1 1/4" NPT	67.8	27.2	40.7	3.8	3.9	32	68
				3		63.4	22.8					57
QF-5-56*	B	7.5	6"	3	1 1/4" MPT	79.5	24.2	55.3	5.4	4.6	45	99
QF-5-75*	B	10	6"	3	1 1/4" MPT	96.2	25.5	70.7	5.4	4.6	58	108

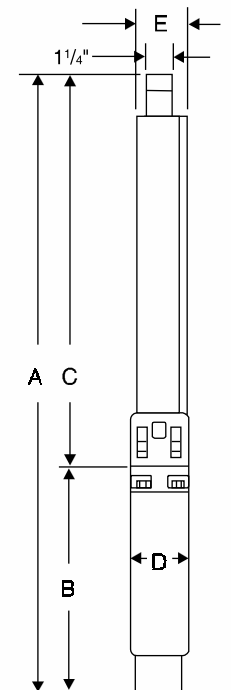

Fig. B

NOTES: All models suitable for use in 4" wells, unless otherwise noted.

* Built into sleeve 1 1/4" MPT discharge, 6" min. well dia.

PERFORMANCE CURVE

25 GPM

MODEL QF 6

FLOW RANGE: 18 -32 GPM OUTLET SIZE: 1 1/2 " NPT NOMINAL DIA. 4"

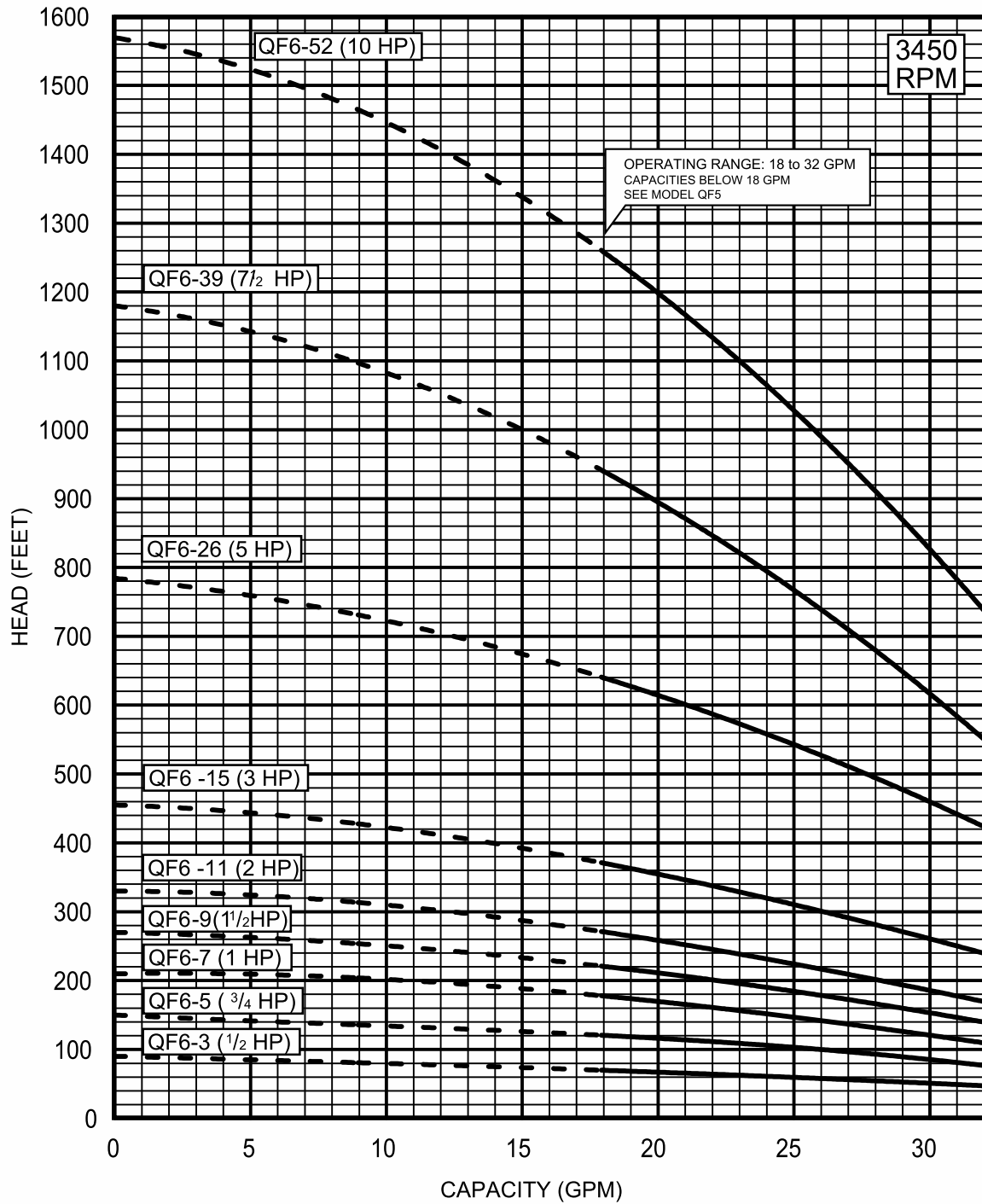

SPECIFICATIONS SUBJECT TO CHANGE WITHOUT NOTICE.
4" MOTOR STANDARD, .5-5 HP/3450 RPM.
6" MOTOR STANDARD, 7.5-10HP/3450 RPM.

Performance conforms to ISO 9906 Annex A
@ 2 ft. min. submergence.

TECHNICAL DATA

25GPM

MODEL QF 6

2 WIRE

DIMENSIONS AND WEIGHTS

MODEL NO.	FIG.	HP	MOTOR SIZE	Ph	DISCH. SIZE	DIMENSIONS IN INCHS					APPROX SHIPPING WEIGHT (lbs)	
						A	B	C	D	E	PUMP	MOTOR
QF6 -3	A	0.5	4"	1	1 1/2" NPT	21.5	9.5	12.0	3.8	3.9	11	22
QF6 -5	A	0.75	4"	1	1 1/2" NPT	24.3	10.7	13.6	3.8	3.9	12	24
QF6- 7	A	1	4"	1	1 1/2" NPT	26.7	11.5	15.3	3.8	3.9	13	26
QF6-9	A	1.5	4"	1	1 1/2" NPT	31.7	14.8	16.9	3.8	3.9	14	35

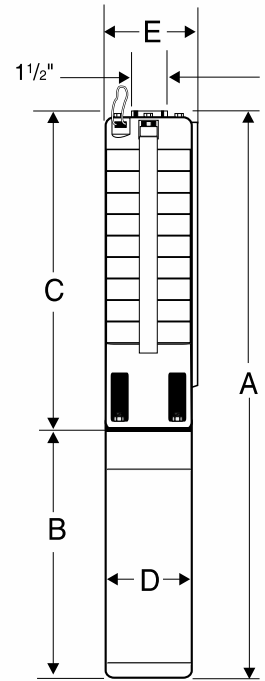

Fig. A

3 WIRE

MODEL NO.	FIG.	HP	MOTOR SIZE	Ph	DISCH. SIZE	DIMENSIONS IN INCHS					APPROX SHIPPING WEIGHT (lbs)	
						A	B	C	D	E	PUMP	MOTOR
QF6 -3	A	0.5	4"	1/3	1 1/2" NPT	21.5	9.5	12.0	3.8	3.9	11	22
						22.7	10.7					24
QF6 -5	A	0.75	4"	1/3	1 1/2" NPT	25.1	11.5	13.6	3.8	3.9	12	24
						25.1	11.5					24
QF6- 7	A	1	4"	1/3	1 1/2" NPT	26.7	11.5	15.3	3.8	3.9	13	26
						26.7	11.5					26
QF6-9	A	1.5	4"	1/3	1 1/2" NPT	30.3	13.3	16.9	3.8	3.9	14	26
						30.3	13.3					26
QF6-11	A	2	4"	1/3	1 1/2" NPT	34.5	15.9	18.6	3.8	3.9	15	37
						34.5	15.9					37
QF6-15	A	3	4"	1/3	1 1/2" NPT	43.1	21.2	21.9	3.8	3.9	17	53
						43.1	21.2					53
QF6-26	A	5	4"	1/3	1 1/2" NPT	58.1	27.2	30.9	3.8	3.9	23	68
						58.1	27.2					57
QF6-39*	A	7.5	6"	3	1 1/2" NPT	65.9	24.2	41.7	5.4	4.6	30	99
QF6-52*	B	10	6"	3	1 1/2" NPT	77.8	25.5	52.4	5.4	5.4	37	108

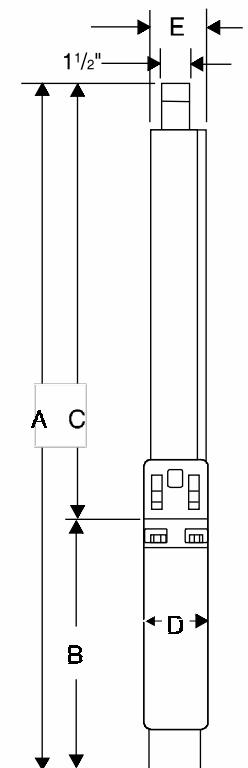

Fig. B

NOTES: All models suitable for use in 4" wells, unless otherwise noted.

* Built into sleeve 1 1/2" MPT discharge, 6" min. well dia.

PERFORMANCE CURVE

40 GPM

MODEL QF 12

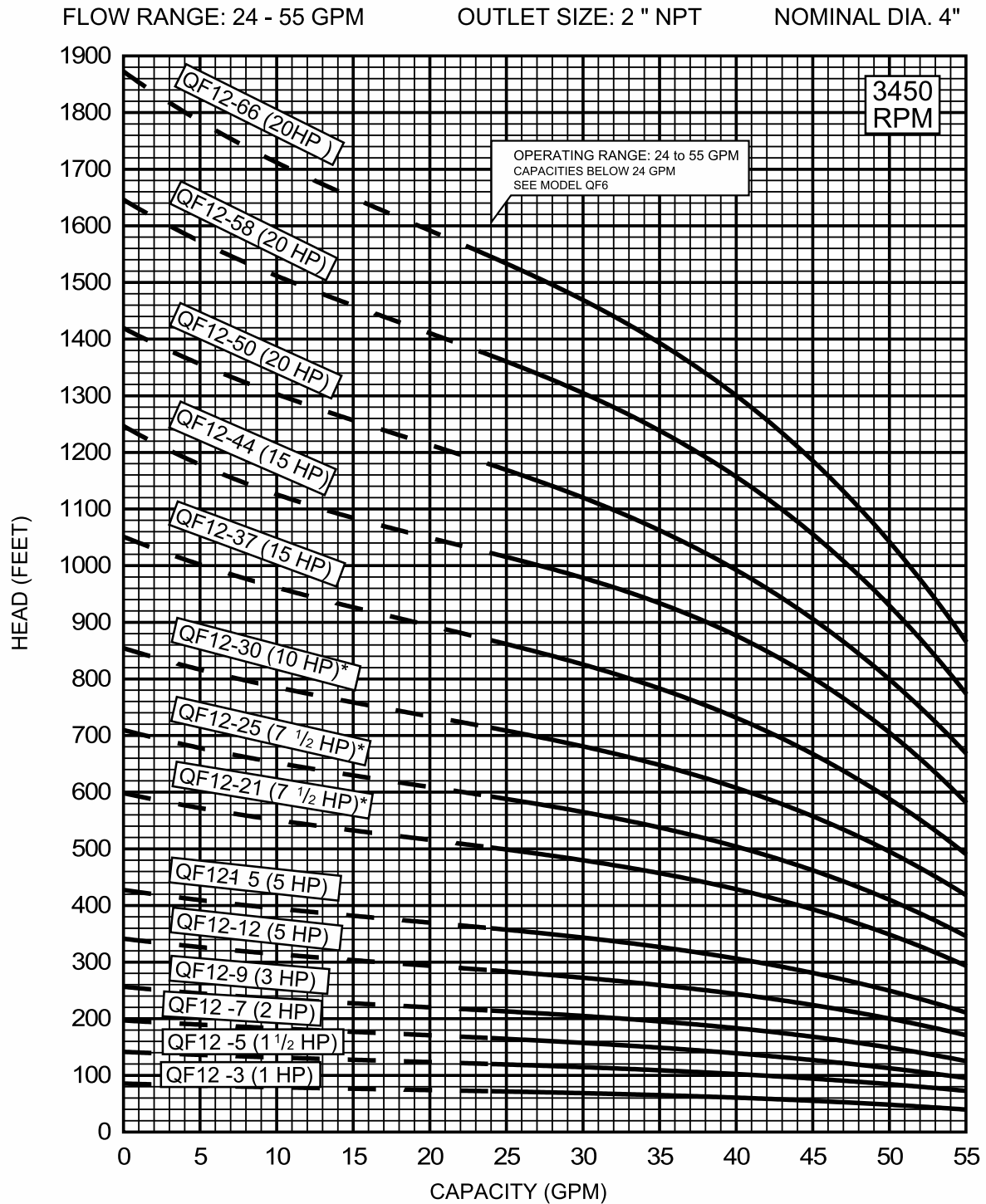

SPECIFICATIONS SUBJECT TO CHANGE WITHOUT NOTICE.
 4" MOTOR STANDARD, 1-10 HP/3450 RPM.
 6" MOTOR STANDARD, 15-20 HP/3450 RPM.
 * Also available with 6" motor.

Performance conforms to ISO 9906 Annex A
 @ 5 ft. min. submergence.

TECHNICAL DATA

40 GPM

MODEL QF 12

DIMENSIONS AND WEIGHTS

MODEL NO.	FIG.	HP	MOTOR SIZE	Ph	DISCH. SIZE	DIMENSIONS IN INCHES					APPROX	
						A	B	C	D	E	PUMP	MOTOR
QF12 -3	A	1	4"	1/3	2" NPT	26.1	11.5	14.6	3.8	3.9	13	26
						26.1	11.5					26
QF12 -5	A	1.5	4"	1/3	2" NPT	31.3	13.3	17.9	3.8	3.9	15	33
						31.3	13.3					33
QF12 -7	A	2	4"	1/3	2" NPT	37.1	15.9	21.2	3.8	3.9	18	37
						37.1	15.9					37
QF12 -9	A	3	4"	1/3	2" NPT	45.6	21.2	24.4	3.8	3.9	20	53
						45.6	21.2					53
QF12 -12	A	5	4"	1/3	2" NPT	56.5	27.2	29.4	3.8	3.9	23	68
						52.1	22.8					57
QF12 -15	A	5	4"	1/3	2" NPT	61.4	27.2	34.3	3.8	3.9	27	68
						57.0	22.8					57
QF12 -21*	A	7.5	4"	3	2" NPT	74.2	30.2	44.1	3.8	3.9	34	77
QF12 -25*	A	7.5	4"	3	2" NPT	80.8	30.2	50.6	3.8	3.9	38	77
QF12 -30*	A	10	4"	3	2" NPT	86.8	32.5	58.8	3.8	3.9	46	84
QF12 -37	A	15	6"	3	2" NPT	100.9	28.0	72.9	5.4	5.4	58	119
QF12 -44	A	15	6"	3	2" NPT	112.5	28.0	84.5	5.4	5.4	68	119
QF12 -50**	B	20	6"	3	2" MPT	125.0	30.6	94.4	5.4	5.5	77	132
QF12 -58**	B	20	6"	3	2" MPT	138.2	30.6	107.6	5.4	5.5	86	132
QF12 -66**	B	20	6"	3	2" MPT	151.5	30.6	120.9	5.4	5.5	96	132

NOTES: All models suitable for use in 4" wells, unless otherwise noted.

* Also available with 6" motor.

** Built into sleeve 2" MPT discharge, 6" min. well dia.

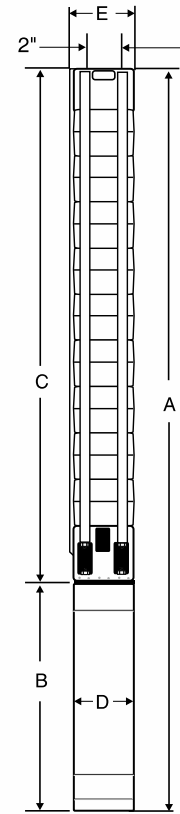

Fig. A

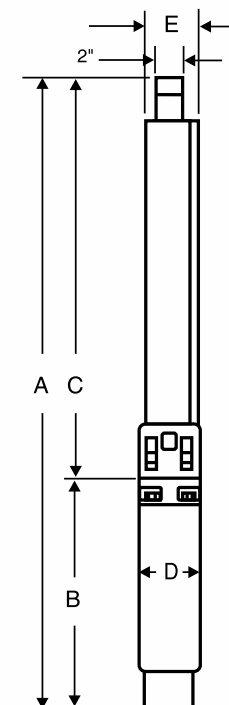

Fig. B

PERFORMANCE CURVE

60 GPM

MODEL QF 20

FLOW RANGE: 40 -75 GPM

OUTLET SIZE: 2 " NPT

NOMINAL DIA. 4"

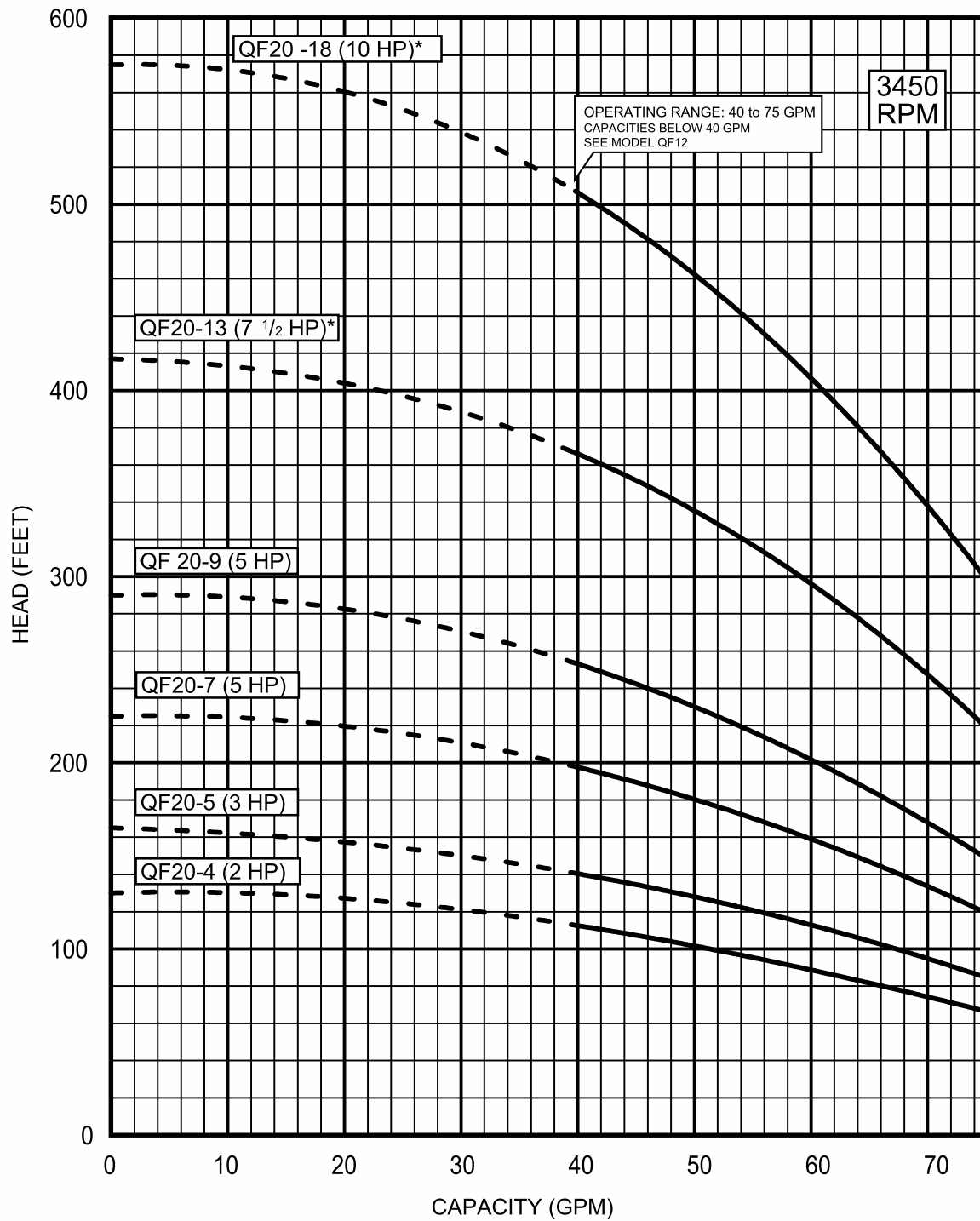

SPECIFICATIONS SUBJECT TO CHANGE WITHOUT NOTICE.
* Also available with 6" motor.

Performance conforms to ISO 9906 Annex A
@ 5 ft. min. submergence.

TECHNICAL DATA

60 GPM

MODEL QF 20

DIMENSIONS AND WEIGHTS

MODEL NO.	FIG.	HP	MOTOR SIZE	Ph	DISCH. SIZE	DIMENSIONS IN INCHES					APPROX	
						A	B	C	D	E	PUMP	MOTOR
QF20-4	A	2	4"	1	2" NPT	35.6	15.9	19.7	3.8	3.9	16	37
				3		35.6	15.9					37
QF20-5	A	3	4"	1	2" NPT	43.4	21.2	22.2	3.8	3.9	18	53
				3		43.4	21.2					53
QF20-7	A	5	4"	1	2" NPT	54.5	27.2	27.4	3.8	3.9	21	68
				3		50.1	22.8					57
QF20-9	A	5	4"	1	2" NPT	59.7	27.2	32.5	3.8	3.9	24	68
				3		55.3	22.8					57
QF20-13*	A	7.5	4"	3	2" NPT	72.9	30.2	42.7	3.8	3.9	30	77
QF20-18*	A	10	4"	3	2" NPT	88.0	32.5	55.5	3.8	3.9	39	84

NOTES: All models suitable for use in 4" wells, unless otherwise noted.
 * Also available with 6" motor.

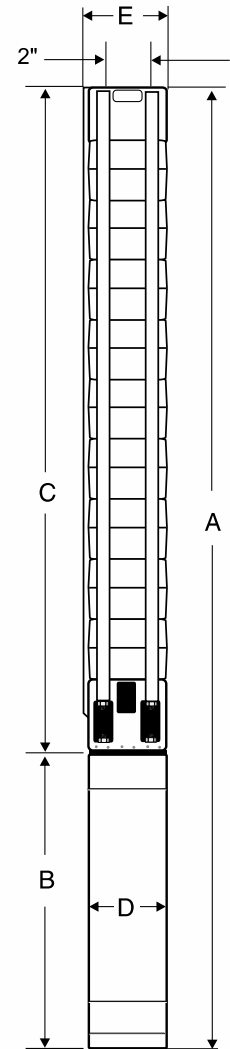

Fig. A

PERFORMANCE CURVE

75 GPM

MODEL QF 25

FLOW RANGE: 45 - 95 GPM OUTLET SIZE: 2" NPT NOMINAL DIA.: 4"

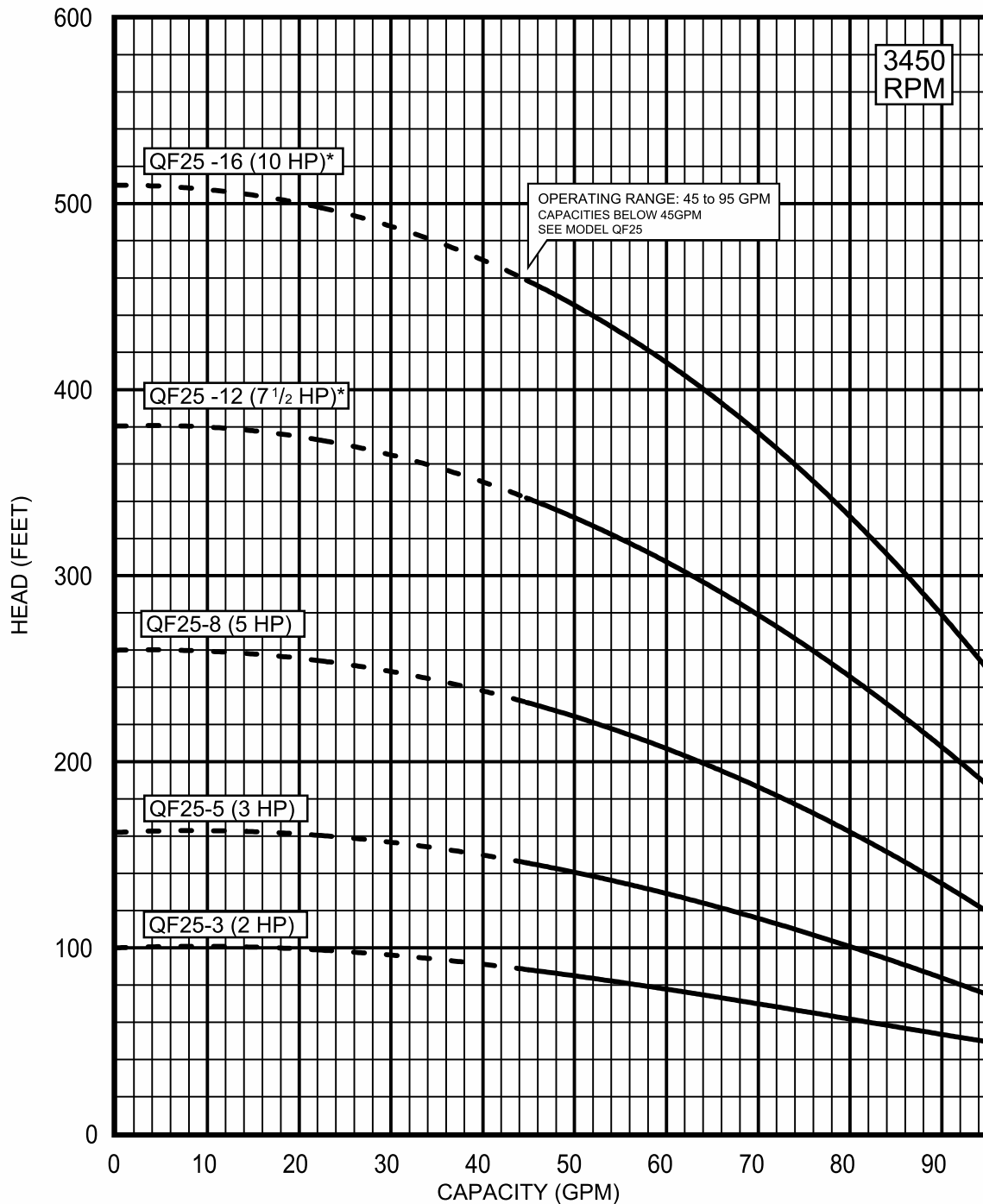

SPECIFICATIONS SUBJECT TO CHANGE WITHOUT NOTICE.

4" motor standard, 2-10 HP/3450 RPM

* Also available with 6" motor. Performance is the same only at Best Efficiency Point.

Consult factory for actual performance.

Performance conforms to ISO 9906 Annex A @ 5 ft. min. submergence.

PERFORMANCE CURVE

75 GPM

MODEL QF 25

DIMENSIONS AND WEIGHTS

MODEL NO.	FIG.	HP	MOTOR SIZE	Ph	DISCH. SIZE	DIMENSIONS IN INCHES					APPROX	
						A	B	C	D	E	PUMP	MOTOR
QF25-3	A	2	4"	1	2" NPT	33.1	15.9	17.2	3.8	3.9	15	37
				3		33.1	15.9					37
QF25-5	A	3	4"	1	2" NPT	43.5	21.2	22.3	3.8	3.9	18	53
				3		43.5	21.2					53
QF25-8	A	5	4"	1	2" NPT	57.1	27.2	30.0	3.8	3.9	23	68
				3		52.7	22.8					57
QF25-12*	A	7.5	4"	3	2" NPT	70.4	30.2	40.2	3.8	3.9	29	77
QF25-16*	A	10	4"	3	2" NPT	82.9	32.5	50.4	3.8	3.9	36	84

NOTES: All models suitable for use in 4" wells, unless otherwise noted.
 * Also available with 6" motor. Performance is the same only at Best Efficiency Point.
 Consult factory for actual performance.

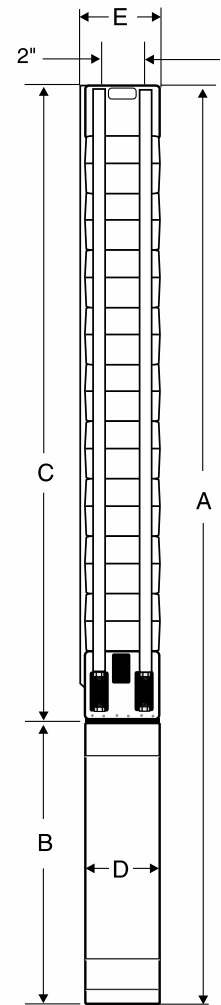

Fig. A

6- Inch,8- Inch & 10-Inch SUBMERSIBLES

Performance Curve And Technical Data
6- Inch,8- Inch & 10-Inch Submersibles



PERFORMANCE CURVE

85 GPM

MODEL QF 30

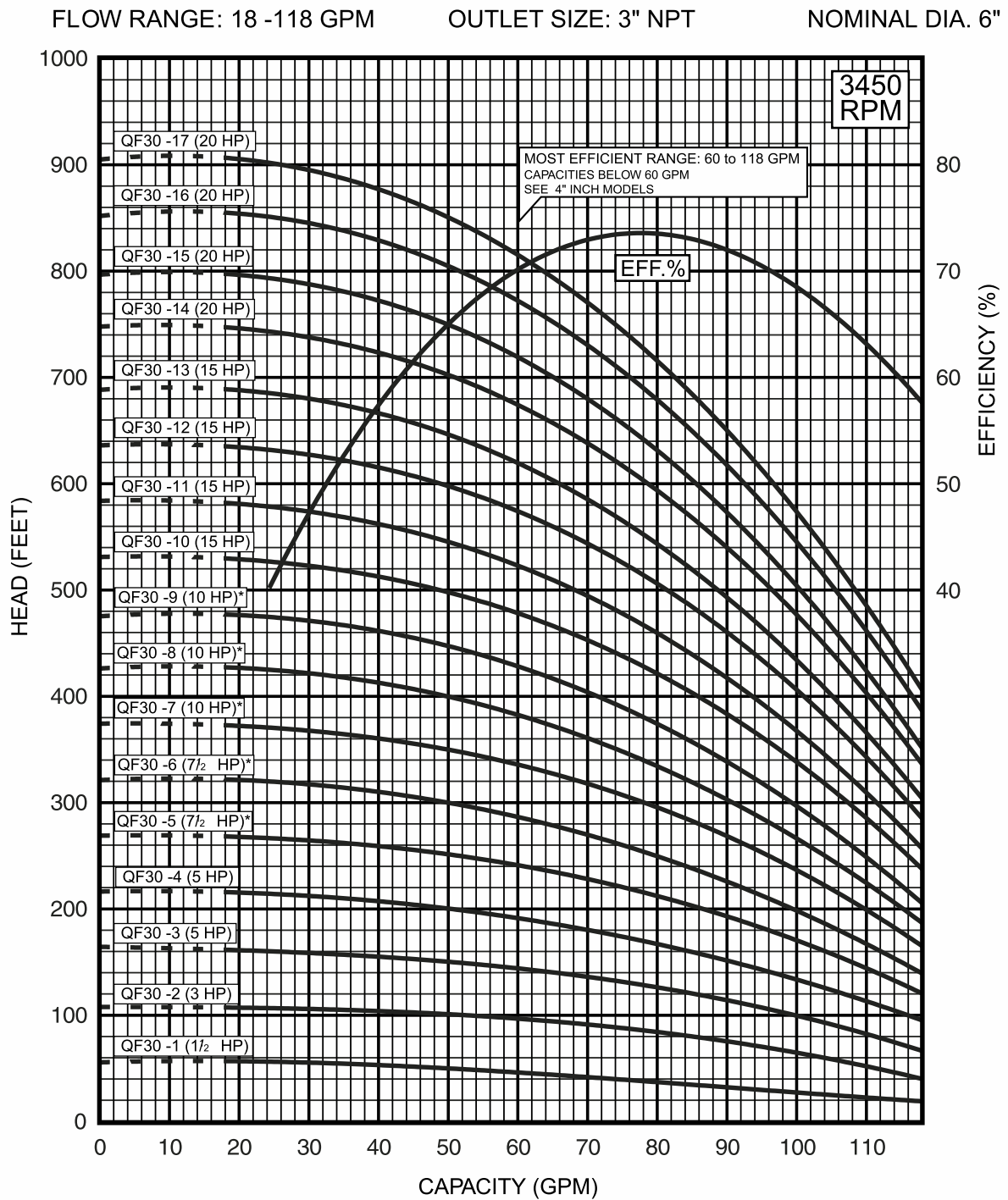

SPECIFICATIONS SUBJECT TO CHANGE WITHOUT NOTICE.
 4" MOTOR STANDARD, 1.5-5 HP/3450 RPM
 6" MOTOR STANDARD, 7.5-50 HP/3450 RPM.
 *Alternate motor sizes available.

Performance conforms to ISO 9906 Annex A
 @ 5 ft. min. submergence.

PERFORMANCE CURVE

85 GPM

MODEL QF 30

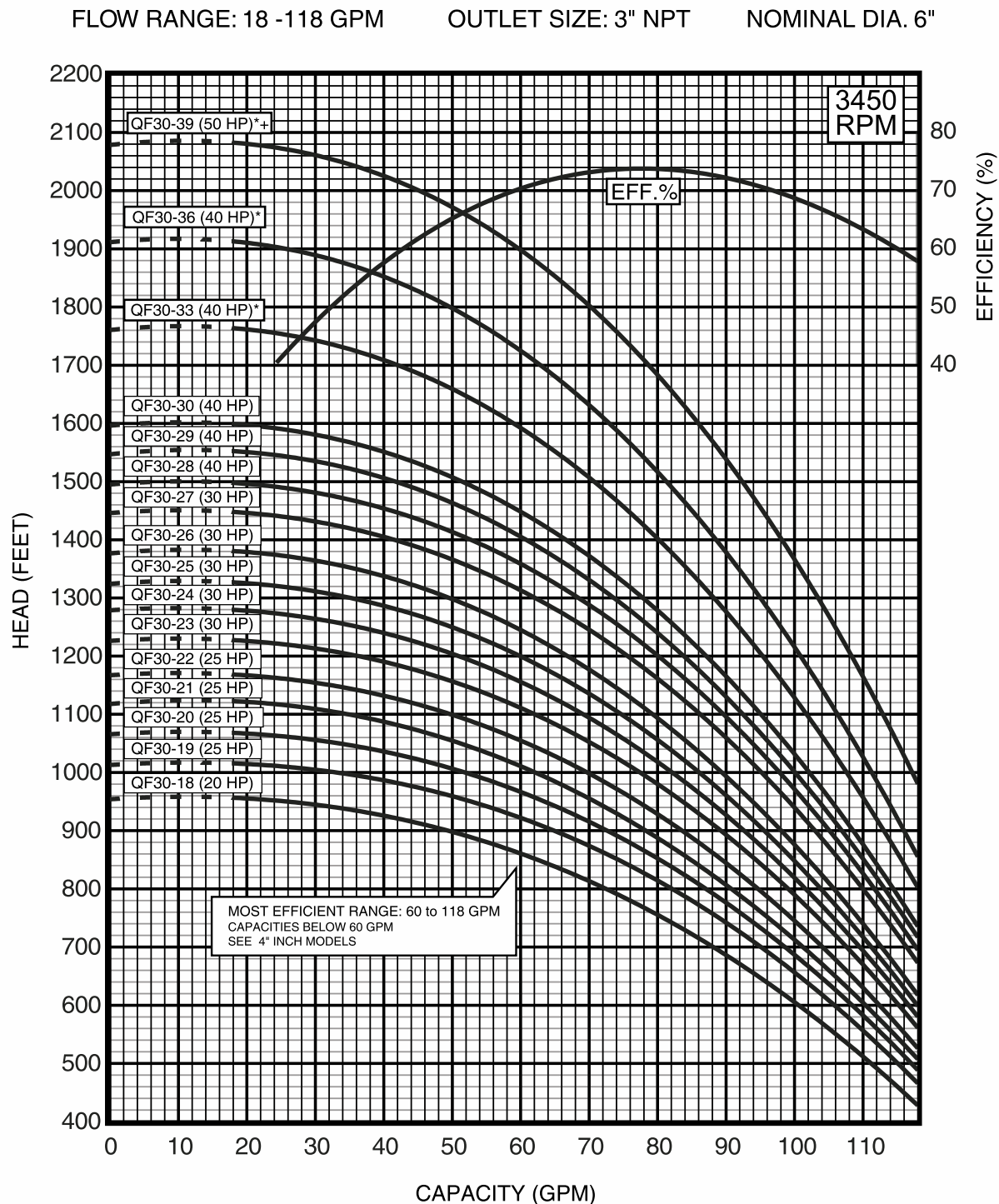

SPECIFICATIONS SUBJECT TO CHANGE WITHOUT NOTICE.
 * Built into sleeve 3" male NPT discharge/ 8" min. well diameter.
 6" MOTOR STANDARD, 7.5-50 HP/3450 RPM.
 + Alternate motor sizes available.

Performance conforms to ISO 9906 Annex A
 @ 5 ft. min. submergence.

TECHNICAL DATA

85 GPM

MODEL QF 30

DIMENSIONS AND WEIGHTS

MODEL NO	FIG.	HP	MOTOR SIZE	Ph	DISCH. SIZE	DIMENSIONS IN INCHES					APPROX SHIPPING WEIGHT (lbs)	
						A	B	C	D	E	PUMP	MOTOR
QF30-1	A	1.5	4"	1	3" NPT	26.3	13.3	13.0	3.8	5.2	17	33
				3		26.3	13.3					33
QF30-2	A	3	4"	1	3" NPT	36.5	21.2	15.4	3.8	5.2	19	53
				3		36.5	21.2					53
QF30-3	A	5	4"	1	3" NPT	44.9	27.2	17.7	3.8	5.2	22	68
				3		40.5	22.8					57
QF30-4	A	5	4"	1	3" NPT	47.3	27.2	20.1	3.8	5.2	25	68
				3		42.9	22.8					57
QF30-5	A	7.5	4"	3	3" NPT	52.7	30.2	22.5	3.8	5.2	28	77
QF30-6	A	7.5	4"	3	3" NPT	55.1	30.2	24.9	3.8	5.2	31	77
QF30-7	A	10	4"	3	3" NPT	59.7	32.5	27.3	3.8	5.2	34	84
QF30-8	A	10	4"	3	3" NPT	62.1	32.5	29.6	3.8	5.2	36	84
QF30-9	A	10	4"	3	3" NPT	64.5	32.5	32.0	3.8	5.2	39	84
QF30-5	A	7.5	6"	3	3" NPT	47.0	24.2	22.8	5.4	5.6	29	108
QF30-6	A	7.5	6"	3	3" NPT	49.4	24.2	25.2	5.4	5.6	32	108
QF30-7	A	10	6"	3	3" NPT	53.0	25.4	27.6	5.4	5.6	35	108
QF30-8	A	10	6"	3	3" NPT	55.4	25.4	30.0	5.4	5.6	38	108
QF30-9	A	10	6"	3	3" NPT	57.8	25.4	32.4	5.4	5.6	41	108
QF30-10	A	15	6"	3	3" NPT	62.8	28.0	34.8	5.4	5.6	44	119
QF30-11	A	15	6"	3	3" NPT	65.2	28.0	37.2	5.4	5.6	48	119
QF30-12	A	15	6"	3	3" NPT	67.6	28.0	39.6	5.4	5.6	51	119
QF30-13	A	15	6"	3	3" NPT	70.0	28.0	42.0	5.4	5.6	54	119
QF30-14	A	20	6"	3	3" NPT	75.0	30.6	44.4	5.4	5.6	57	132
QF30-15	A	20	6"	3	3" NPT	77.4	30.6	46.8	5.4	5.6	61	132
QF30-16	A	20	6"	3	3" NPT	79.7	30.6	49.1	5.4	5.6	64	132
QF30-17	A	20	6"	3	3" NPT	82.1	30.6	51.5	5.4	5.6	67	132
QF30-18	A	20	6"	3	3" NPT	84.5	30.6	53.9	5.4	5.6	71	132
QF30-19	A	25	6"	3	3" NPT	89.4	33.1	56.3	5.4	5.6	74	145
QF30-20	A	25	6"	3	3" NPT	91.8	33.1	58.7	5.4	5.6	77	145
QF30-21	A	25	6"	3	3" NPT	94.2	33.1	61.1	5.4	5.6	81	145
QF30-22	A	25	6"	3	3" NPT	96.6	33.1	63.5	5.4	5.6	84	145
QF30-23	A	30	6"	3	3" NPT	101.6	35.7	65.9	5.4	5.6	87	158
QF30-24	A	30	6"	3	3" NPT	104.0	35.7	68.3	5.4	5.6	90	158
QF30-25	A	30	6"	3	3" NPT	106.4	35.7	70.7	5.4	5.6	94	158
QF30-26	A	30	6"	3	3" NPT	108.8	35.7	73.1	5.4	5.6	97	158
QF30-27	A	30	6"	3	3" NPT	116.3	40.8	75.5	5.4	5.6	100	158
QF30-28	A	40	6"	3	3" NPT	118.7	40.8	77.9	5.4	5.6	104	220
QF30-29	A	40	6"	3	3" NPT	121.1	40.8	80.3	5.4	5.6	107	220
QF30-30	A	40	6"	3	3" NPT	123.5	40.8	82.7	5.4	5.6	110	220
QF30-33*	B	40	6"	3	3" NPT	130.6	40.8	89.8	5.4	6.9	120	220
QF30-36*	B	40	6"	3	3" NPT	137.8	40.8	97.0	5.4	6.9	130	220
QF30-39*	B	50	6"	3	3" NPT	162.0	57.8	104.2	5.4	6.9	140	308
QF30-33*	B	40	8"	3	3" NPT	126.4	35.8	90.6	7.5	6.9	126	220
QF30-36*	B	40	8"	3	3" NPT	133.5	35.8	97.7	7.5	6.9	136	220
QF30-39*	B	50	8"	3	3" NPT	143.6	38.8	104.8	7.5	6.9	147	308

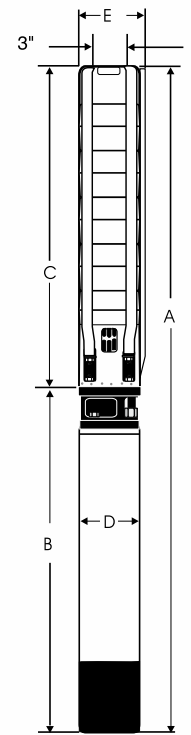

Fig. A

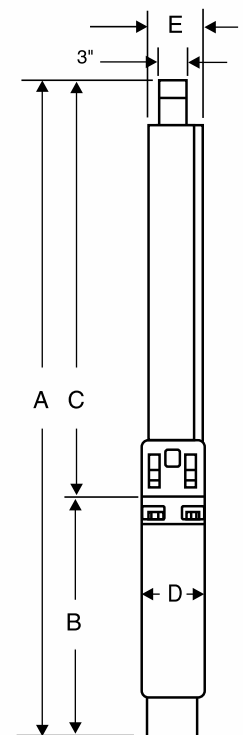

Fig. B

NOTES: All models suitable for use in 6" wells, unless otherwise noted.
 * Built into sleeve 3" NPT discharge, 8" min. well dia.

PERFORMANCE CURVE

150 GPM

MODEL QF 50

FLOW RANGE: 30- 220 GPM OUTLET SIZE: 3" NPT NOMINAL DIA. 6"

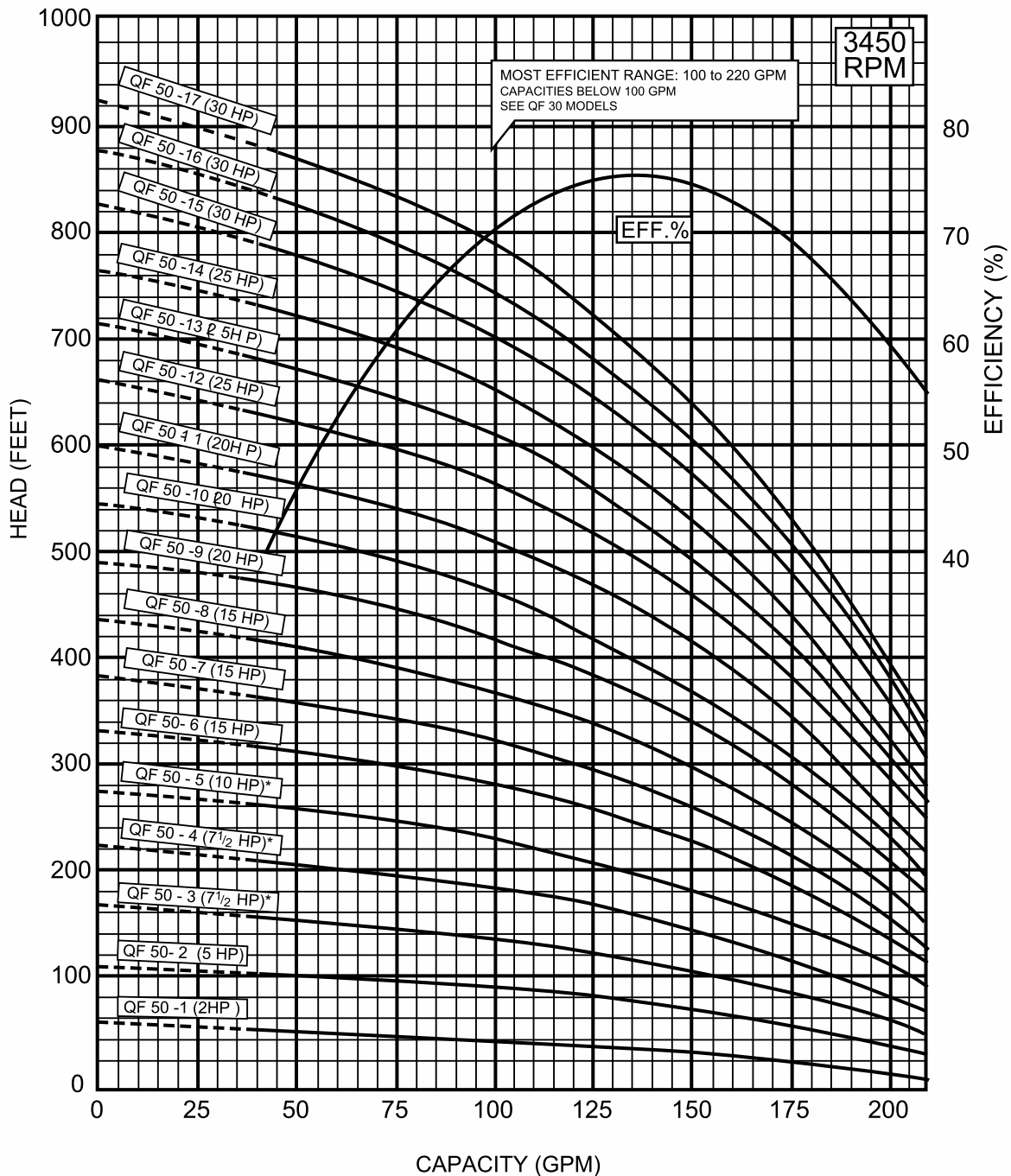

SPECIFICATIONS SUBJECT TO CHANGE WITHOUT NOTICE.

4" MOTOR STANDARD, 2-10 HP/3450 RPM

6" MOTOR STANDARD, 7.5-60 HP/3450 RPM

8" MOTOR STANDARD, 75 HP/3525 RPM

* Alternate motor sizes available

Performance conforms to ISO 9906 Annex A
@ 5 ft. min. submergence.

PERFORMANCE CURVE

150 GPM

MODEL QF 50

FLOW RANGE: 30- 220 GPM OUTLET SIZE: 3" NPT NOMINAL DIA. 6"

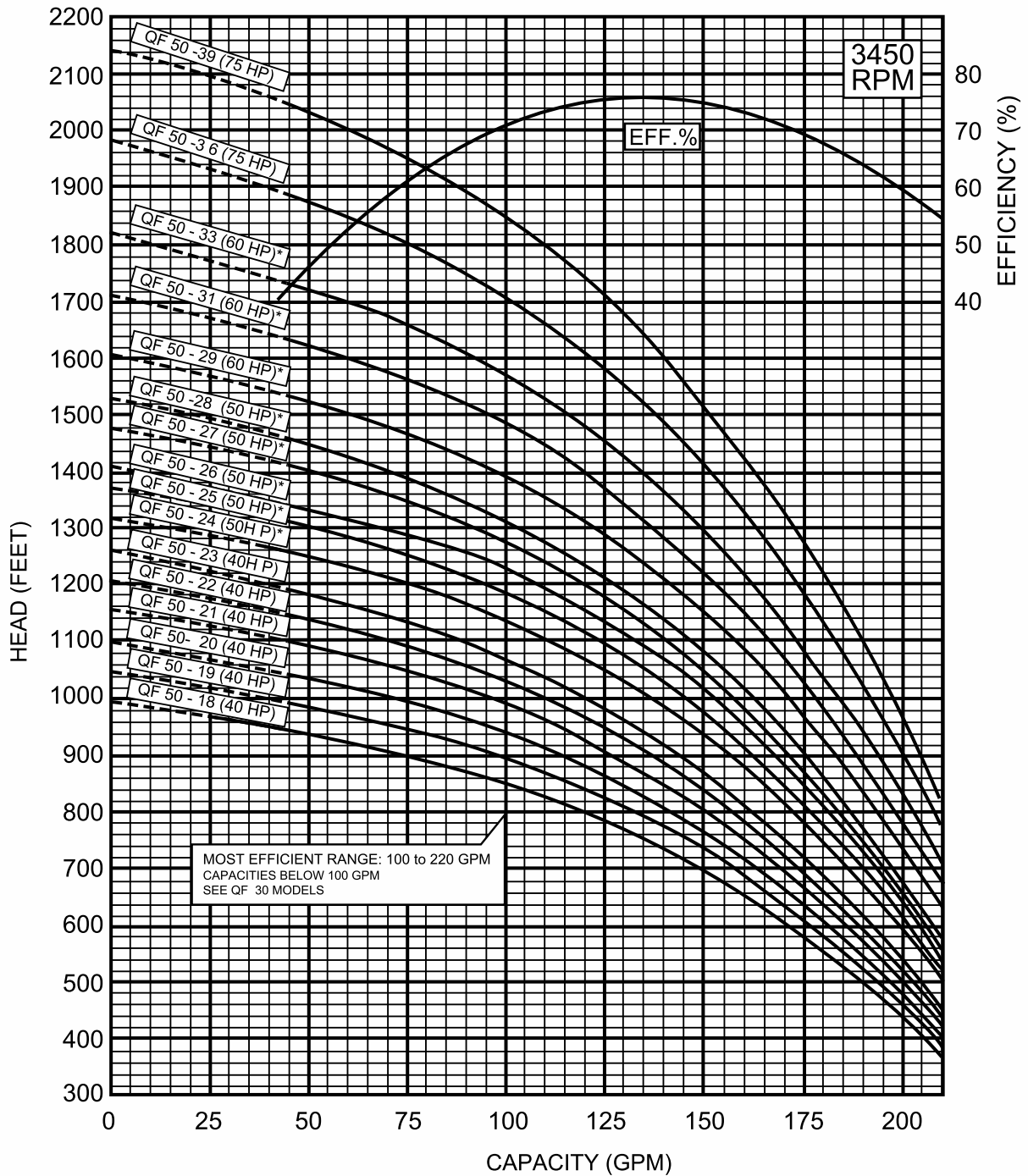

SPECIFICATIONS SUBJECT TO CHANGE WITHOUT NOTICE.
 6" MOTOR STANDARD, 7.5-60 HP/3450 RPM.
 8" MOTOR STANDARD, 75 HP/3525 RPM
 * Alternate motor sizes available

Performance conforms to ISO 9906 Annex A
 @ 5 ft. min. submergence.

TECHNICAL DATA

150 GPM

MODEL QF 50

Dimensions and weight

MODEL NO.	FIG.	HP	MOTOR SIZE	Ph	DISCH. SIZE	DIMENSIONS IN INCHES					APPROX SHIPPING WEIGHT (lbs)	
						A	B	C	D	E	PUMP	MOTOR
QF50-1	A	2	4"	1	3" NPT	30.2	15.9	14.3	3.8	5.2	18	37
				3		30.2	15.9					37
QF50-2	A	5	4"	1	3" NPT	45.3	27.2	18.1	3.8	5.2	22	68
				3		45.3	27.2					57
QF50-3	A	7.5	4"	3	3" NPT	52.1	30.2	21.9	3.8	5.2	26	77
QF50-4	A	7.5	4"	3	3" NPT	55.9	30.2	25.7	3.8	5.2	31	77
QF50-5	A	10	4"	3	3" NPT	62.0	32.5	29.5	3.8	5.2	35	84
QF50-4	A	7.5	6"	3	3" NPT	55.3	24.2	31.1	5.4	5.6	35	99
QF50-5	A	10	6"	3	3" NPT	59.1	25.5	33.6	5.4	5.6	40	108
QF50-6	A	15	6"	3	3" NPT	64.2	28.0	36.2	5.4	5.6	44	119
QF50-7	A	15	6"	3	3" NPT	66.7	28.0	38.7	5.4	5.6	48	119
QF50-8	A	15	6"	3	3" NPT	69.2	28.0	41.2	5.4	5.6	53	119
QF50-9	A	20	6"	3	3" NPT	74.3	30.6	43.8	5.4	5.6	57	132
QF50-10	A	20	6"	3	3" NPT	76.9	30.6	46.3	5.4	5.6	61	132
QF50-11	A	20	6"	3	3" NPT	79.4	30.6	48.8	5.4	5.6	66	132
QF50-12	A	25	6"	3	3" NPT	84.5	33.1	51.4	5.4	5.6	70	145
QF50-13	A	25	6"	3	3" NPT	87.0	33.1	53.9	5.4	5.6	74	145
QF50-14	A	25	6"	3	3" NPT	89.6	33.1	56.4	5.4	5.6	79	145
QF50-15	A	30	6"	3	3" NPT	94.6	35.7	58.9	5.4	5.6	83	158
QF50-16	A	30	6"	3	3" NPT	97.2	35.7	61.5	5.4	5.6	87	158
QF50-17	A	30	6"	3	3" NPT	99.7	35.7	64.0	5.4	5.6	91	158
QF50-18	A	40	6"	3	3" NPT	109.8	43.3	66.5	5.4	5.6	95	220
QF50-19	A	40	6"	3	3" NPT	112.3	43.3	69.1	5.4	5.6	100	220
QF50-20	A	40	6"	3	3" NPT	114.9	43.3	71.6	5.4	5.6	104	220
QF50-21	A	40	6"	3	3" NPT	117.4	43.3	74.1	5.4	5.7	108	220
QF50-22	A	40	6"	3	3" NPT	119.9	43.3	76.7	5.4	5.7	113	220
QF50-23	A	40	6"	3	3" NPT	122.5	43.3	79.2	5.4	5.7	117	220
QF50-24	A	50	6"	3	3" NPT	140.2	58.5	81.7	5.4	6.1	122	308
QF50-25	A	50	6"	3	3" NPT	142.8	58.5	84.3	5.4	6.1	126	308
QF50-26	A	50	6"	3	3" NPT	145.3	58.5	86.8	5.4	6.1	130	308
QF50-27	A	50	6"	3	3" NPT	147.8	58.5	89.3	5.4	6.1	135	308
QF50-28	A	50	6"	3	3" NPT	150.4	58.5	91.9	5.4	7.1	139	308
QF50-29	A	50	6"	3	3" NPT	152.9	58.5	94.4	5.4	7.1	143	308
QF50-31	A	50	8"	3	3" NPT	174.2	44.9	129.3	7.5	7.5	157	361
QF50-33	A	50	8"	3	3" NPT	178.0	44.9	133.1	7.5	7.5	167	361
QF50-24	A	50	8"	3	3" NPT	161.0	44.9	116.1	7.5	7.5	138	361
QF50-25	A	50	8"	3	3" NPT	162.9	44.9	118.0	7.5	7.5	142	361
QF50-26	A	50	8"	3	3" NPT	164.8	44.9	119.9	7.5	7.5	146	361
QF50-27	A	50	8"	3	3" NPT	166.7	44.9	121.8	7.5	7.5	150	361
QF50-28	A	50	8"	3	3" NPT	168.5	44.9	123.7	7.5	7.5	154	361
QF50-29*	B	60	8"	3	3" NPT	174.0	48.4	125.6	7.5	7.5	158	416
QF50-31*	B	60	8"	3	3" NPT	177.8	48.4	129.3	7.5	7.5	165	416
QF50-33*	B	60	8"	3	3" NPT	181.5	48.4	133.1	7.5	7.5	174	416
QF30-36*	B	75	8"	3	3" NPT	191.5	52.8	138.8	7.5	7.5	189	447
QF30-39*	B	75	8"	3	3" NPT	197.2	52.8	144.4	7.5	7.5	200	447

Notes : All models suitable for use in 6" wells, unless otherwise noted.
 * Built into sleeve 3" NPT discharge, 8" min. well dia.

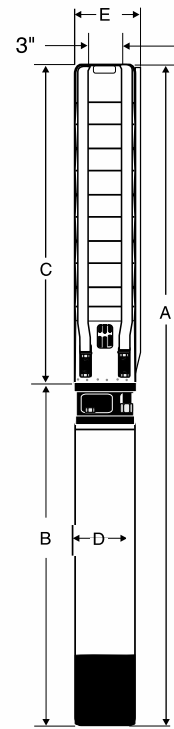

Fig. A

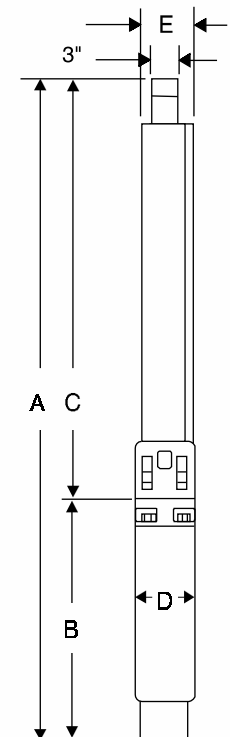

Fig. B

PERFORMANCE CURVE

230 GPM

MODEL QF 75

FLOW RANGE: 160 -320 GPM OUTLET SIZE: 3" NPT NOMINAL DIA. 6"

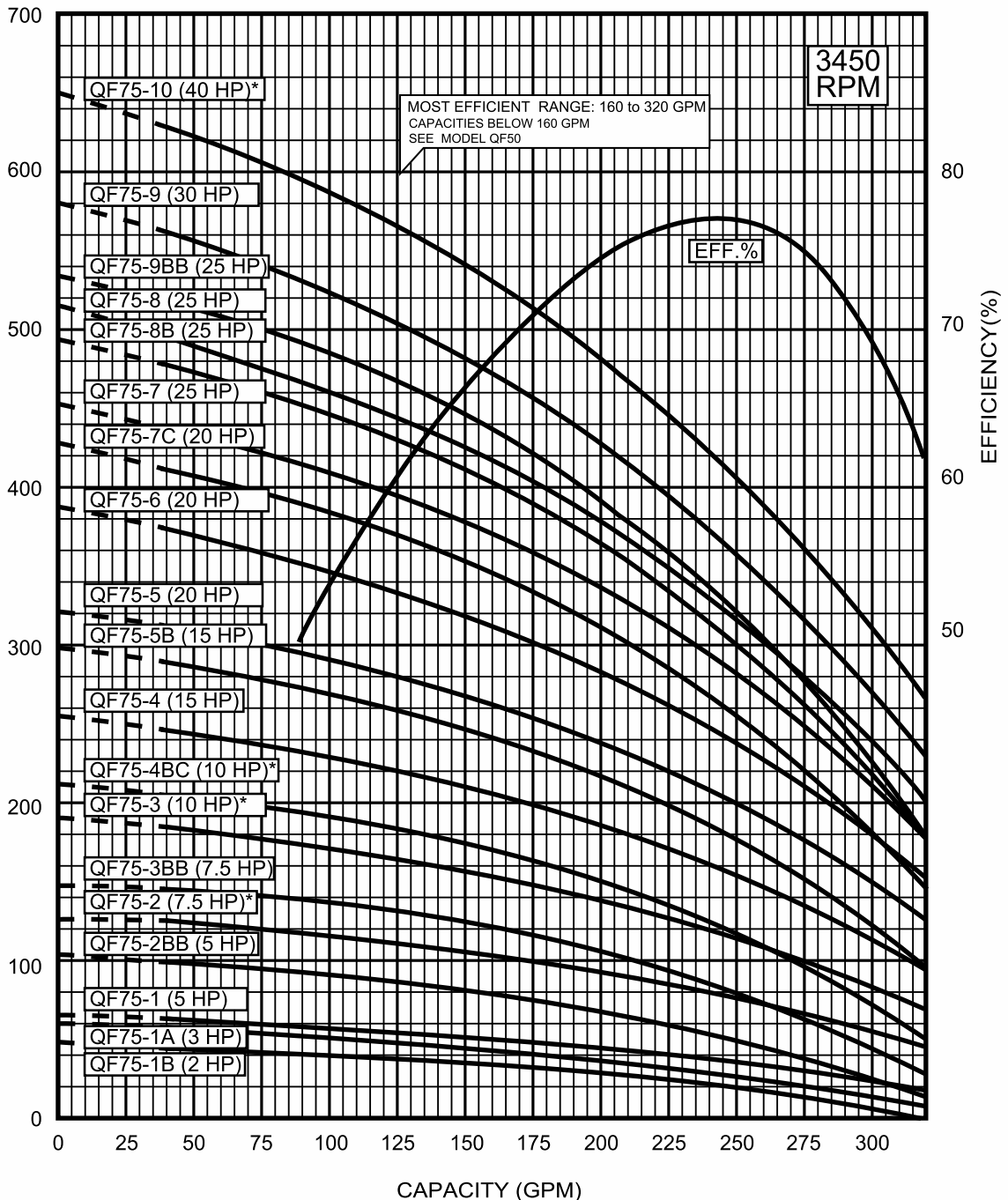

SPECIFICATIONS SUBJECT TO CHANGE WITHOUT NOTICE.
 4" MOTOR STANDARD, 7.5 HP/3450 RPM
 6" MOTOR STANDARD, 7.5-40 HP/3450 RPM.
 8" MOTOR STANDARD, 50-75 HP/3525 RPM.
 * Alternate motor sizes available.

Performance conforms to ISO 9906 Annex A
 @ 8 ft. min. submergence.

PERFORMANCE CURVE

230 GPM

MODEL QF 75

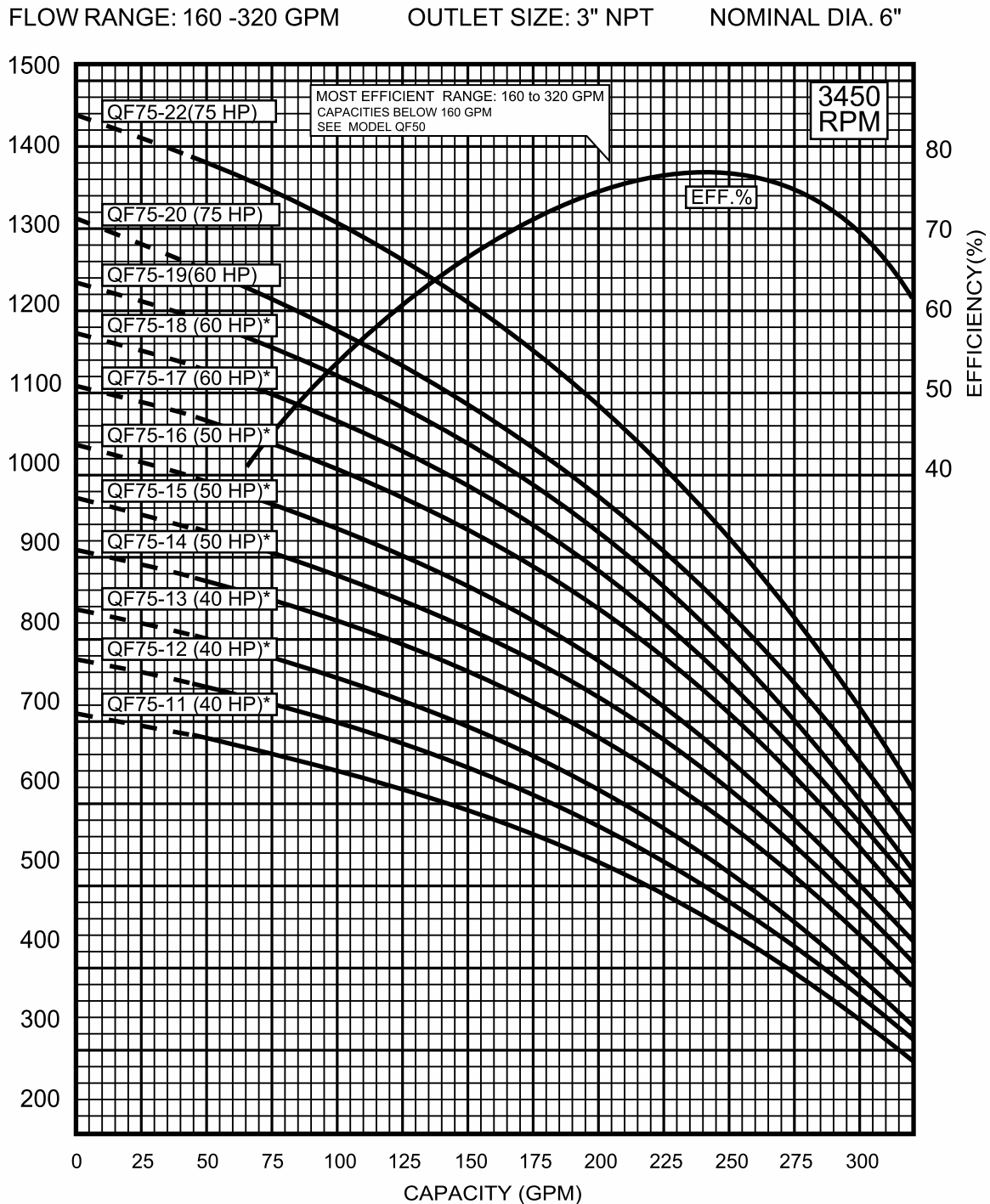

SPECIFICATIONS SUBJECT TO CHANGE WITHOUT NOTICE.
 4" MOTOR STANDARD, 7.5 HP/3450 RPM
 6" MOTOR STANDARD, 7.5-40 HP/3450 RPM.
 8" MOTOR STANDARD, 50-75 HP/3525 RPM.
 * Alternate motor sizes available.

Performance conforms to ISO 9906 Annex A
 @ 8 ft. min. submergence.

TECHNICAL DATA

230 GPM

MODEL QF 75

DIMENSIONS AND WEIGHTS

MODEL NO.	FIG.	HP	MOTOR SIZE	Ph	DISCH. SIZE	DIMENSIONS IN INCHES					APPROX SHIPPING WEIGHT (lbs)	
						A	B	C	D	E	PUMP	MOTOR
QF75 1 B	A	2	4"	1	3" NPT	30.6	15.9	14.7	3.8	5.7	19	37
				3		30.6	15.9					37
QF75 1 A	A	3	4"	1	3" NPT	35.9	21.2	14.7	3.8	5.7	19	53
				3		35.9	21.2					53
QF75 1	A	5	4"	1	3" NPT	41.9	27.2	14.7	3.8	5.7	19	68
				3		37.5	22.8					57
QF75 2 AB	A	5	4"	1	3" NPT	46.4	27.2	19.2	3.8	5.7	25	68
				3		42.0	22.8					57
QF75 2	A	7.5	4"	3	3" NPT	49.4	30.2	19.2	3.8	5.7	25	77
QF75 2	A	7.5	6"	3	3" NPT	43.4	24.2	19.2	5.4	5.7	25	99
QF75 3 BB	A	7.5	4"	3	3" NPT	53.8	30.2	23.6	3.8	5.7	30	77
QF75 3 BB	A	7.5	6"	3	3" NPT	47.8	24.2	23.6	5.4	5.7	30	99
QF75 3	A	10	4"	3	3" NPT	53.8	32.5	23.6	3.8	5.7	30	84
QF75 3	A	10	6"	3	3" NPT	50.2	25.4	24.8	5.4	5.7	36	108
QF75 4BC	A	10	4"	3	3" NPT	60.6	32.5	28.1	3.8	5.7	35	84
QF75 4BC	A	10	6"	3	3" NPT	54.5	25.5	29.1	5.4	5.7	41	108
QF75 4	A	15	6"	3	3" NPT	57.1	28.0	29.1	5.4	5.7	41	119
QF75 5 B	A	15	6"	3	3" NPT	61.4	28.0	33.3	5.4	5.7	46	119
QF75 5	A	20	6"	3	3" NPT	63.8	30.5	33.3	5.4	5.7	46	132
QF75 6	A	20	6"	3	3" NPT	68.1	30.5	37.6	5.4	5.7	51	132
QF75 7 C	A	20	6"	3	3" NPT	72.4	30.5	41.9	5.4	5.7	55	132
QF75 7	A	25	6"	3	3" NPT	75.1	33.1	41.9	5.4	5.7	55	145
QF75 8 B	A	25	6"	3	3" NPT	79.4	33.1	46.2	5.4	5.7	60	145
QF75 8	A	25	6"	3	3" NPT	79.4	33.1	46.2	5.4	5.7	60	145
QF75 9 BB	A	25	6"	3	3" NPT	83.6	33.1	50.5	5.4	5.7	65	145
QF75 9	A	30	6"	3	3" NPT	86.2	35.7	50.5	5.4	5.7	65	158
QF75 10*	A	40	6"	3	3" NPT	98.1	43.3	54.8	5.4	5.7	70	220
QF75 11*	A	40	6"	3	3" NPT	102.4	43.3	59.1	5.4	5.7	75	220
QF75 12*	A	40	6"	3	3" NPT	106.6	43.3	63.4	5.4	5.7	80	220
QF75 13*	A	40	6"	3	3" NPT	110.9	43.3	67.7	5.4	5.7	85	220
QF75 14*	A	50	6"	3	3" NPT	130.5	58.5	72.0	5.4	5.7	90	308
QF75 15*	A	50	6"	3	3" NPT	134.8	58.5	76.3	5.4	5.7	95	308
QF75 16*	A	50	6"	3	3" NPT	139.1	58.5	80.6	5.4	5.7	99	308
QF75 17*	A	60	6"	3	3" NPT	133.3	48.4	84.8	5.4	5.7	105	416
QF75 18*	A	60	6"	3	3" NPT	137.6	48.4	89.1	5.4	5.7	110	416
QF75 19*	A	60	6"	3	3" NPT	141.8	48.4	93.4	5.4	5.7	114	416
QF75 17	A	60	8"	3	3" NPT	135.8	48.4	87.4	7.5	7.6	113	416
QF75 18	A	60	8"	3	3" NPT	140.2	48.4	91.8	7.5	7.6	119	416
QF75 19	A	60	8"	3	3" NPT	144.7	48.4	96.3	7.5	7.6	124	416
QF75 20**	B	75	8"	3	4" M-NPT	153.5	52.8	100.7	7.5	7.6	131	447
QF75 20**	B	75	8"	3	4" M-NPT	162.4	52.8	109.6	7.5	7.6	140	447

NOTES: All models suitable for use in 6" wells, unless equipped with 8" motor.
 * Alternate motor sizes available.
 ** Built into sleeve, 4" NPT, 8" motor required.

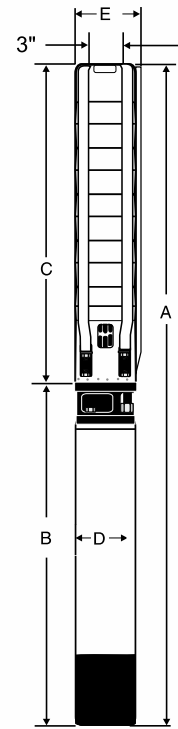

Fig. A

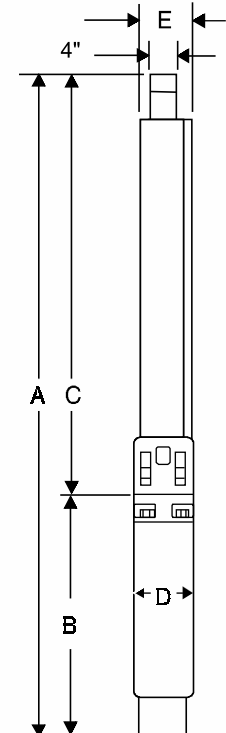

Fig. B

PERFORMANCE CURVE

300 GPM

MODEL QF 100

FLOW RANGE: 60 - 410 GPM

OUTLET SIZE: 3" & 4" NPT*

NOMINAL DIA. 6"

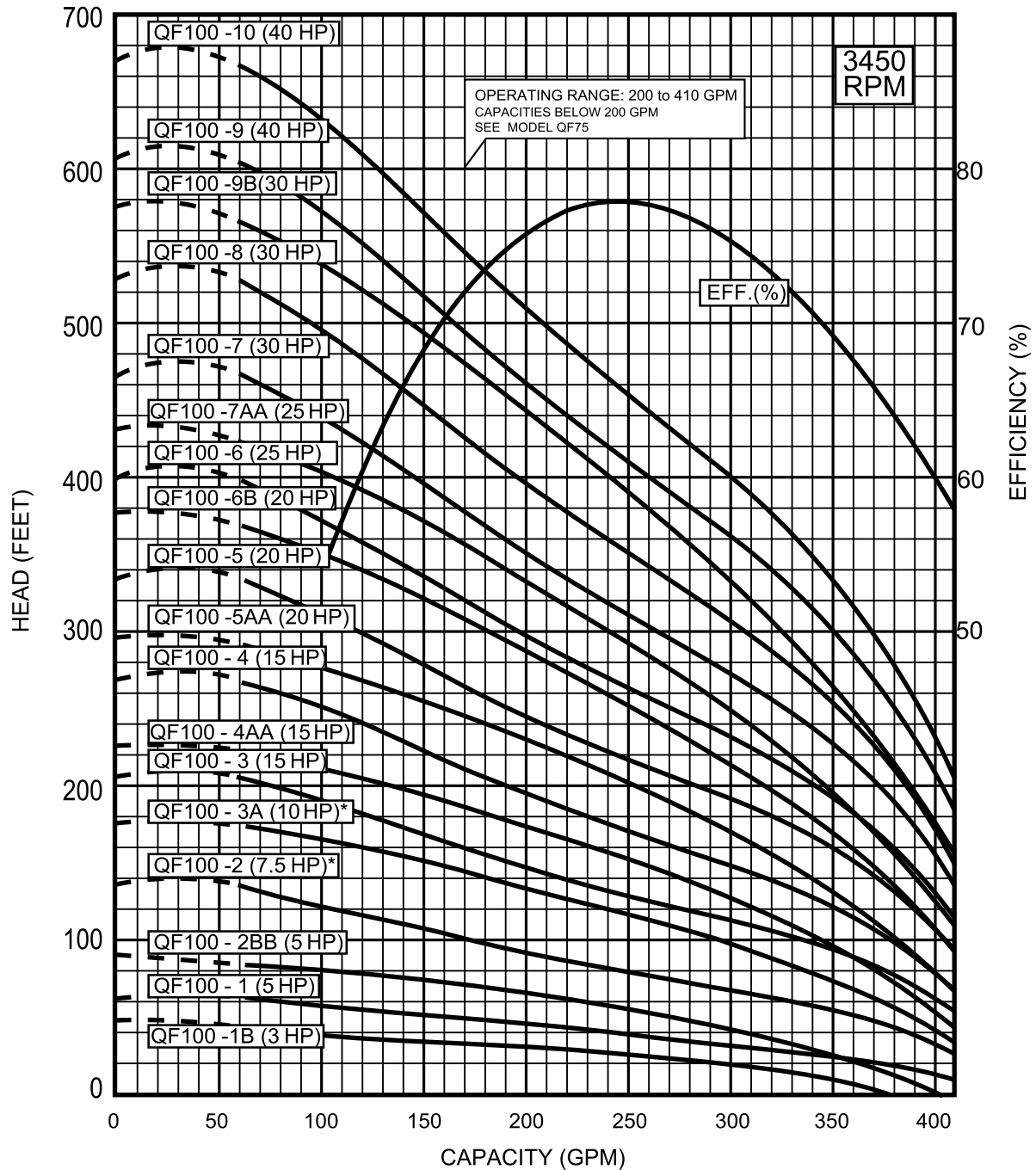

SPECIFICATIONS SUBJECT TO CHANGE WITHOUT NOTICE.
 4" MOTOR STANDARD, 7.5 HP/3450 RPM.
 6" MOTOR STANDARD, 15-50 HP/3450 RPM.
 8" MOTOR STANDARD, 60-75 HP/3525 RPM.
 * 3" NPT 2-7 STAGES, 4" NPT 8-18 STAGES.

Performance conforms to ISO 9906 Annex A
 @ 8 ft. min. submergence.

PERFORMANCE CURVE

300 GPM

MODEL QF 100

FLOW RANGE: 60 - 410 GPM OUTLET SIZE: 3" & 4" NPT* NOMINAL DIA. 6"

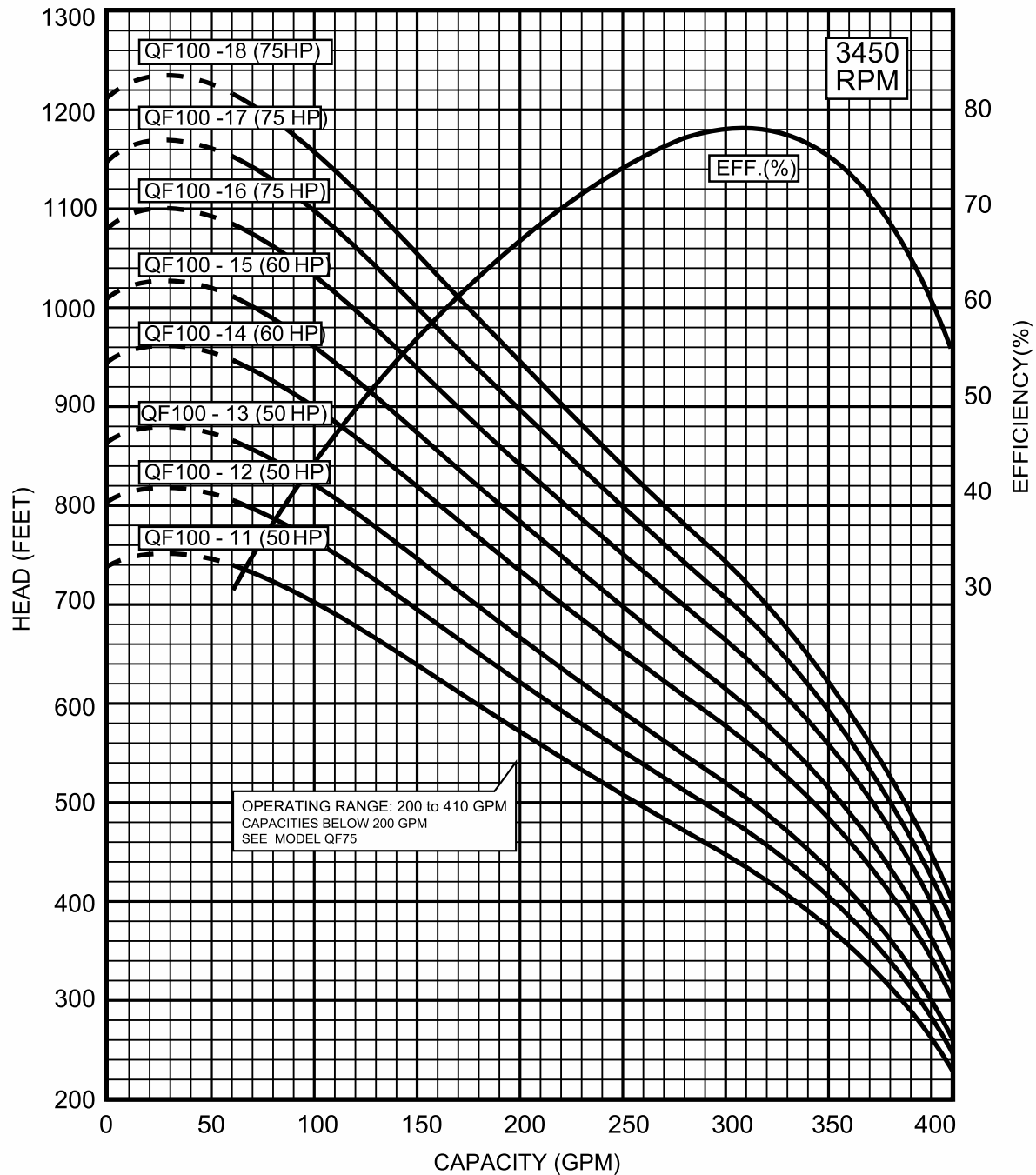

SPECIFICATIONS SUBJECT TO CHANGE WITHOUT NOTICE.
 4" MOTOR STANDARD, 7.5 HP/3450 RPM.
 6" MOTOR STANDARD, 15-50 HP/3450 RPM.
 8" MOTOR STANDARD, 60-75 HP/3525 RPM.
 * 3" NPT 2-7 STAGES, 4" NPT 8-18 STAGES.

Performance conforms to ISO 9906 Annex A
 @ 8 ft. min. submergence.

TECHNICAL DATA

300 GPM

MODEL QF 100

DIMENSIONS AND WEIGHTS

MODEL NO.	FIG.	HP	MOTOR SIZE	Ph	DISCH. SIZE	DIMENSIONS IN INCHES					APPROX SHIPPING WEIGHT (lbs)	
						A	B	C	D	E	PUMP	MOTOR
QF100 1 B	A	3	4"	1	3" NPT	35.6	21.2	14.4	3.8	5.7	20	53
				3		35.6	21.2					53
QF100 1	A	5	4"	1	3" NPT	41.6	27.2	14.4	3.8	5.7	20	68
				3		37.2	22.8					57
QF100 2 BB	A	5	4"	1	3" NPT	46.4	27.2	19.2	3.8	5.7	27	68
				3		42.0	22.8					57
QF100 2	A	7.5	4"	3	3" NPT	49.4	30.2	19.2	3.8	5.7	27	77
QF100 2*	A	7.5	6"	3	3" NPT	43.9	24.2	19.7	5.4	5.7	31	99
QF100 3 A	A	10	4"	3	3" NPT	54.1	30.2	23.9	3.8	5.7	35	84
QF100 3 A	A	10	6"	3	3" NPT	49.6	25.5	24.2	5.4	5.7	37	108
QF100 3	A	15	6"	3	3" NPT	52.2	28.0	24.2	5.4	5.7	37	119
QF100 4 AA	A	15	6"	3	3" NPT	56.6	28.0	28.6	5.4	5.7	43	119
QF100 4	A	15	6"	3	3" NPT	56.6	28.0	28.6	5.4	5.7	43	119
QF100 5 AA	A	20	6"	3	3" NPT	63.6	30.6	33.0	5.4	5.7	49	132
QF100 5	A	20	6"	3	3" NPT	63.6	30.6	33.0	5.4	5.7	49	132
QF100 6 B	A	20	6"	3	3" NPT	68.0	30.6	37.4	5.4	5.7	54	132
QF100 6	A	25	6"	3	3" NPT	65.5	28.0	37.4	5.4	5.7	54	145
QF100 7 AA	A	25	6"	3	3" NPT	69.9	28.0	41.9	5.4	5.7	59	145
QF100 7	A	30	6"	3	4" NPT	77.6	35.7	41.9	5.4	5.7	59	158
QF100 8	A	30	6"	3	4" NPT	82.0	35.7	46.3	5.4	5.7	65	158
QF100 9 B	A	30	6"	3	4" NPT	86.4	35.7	50.7	5.4	5.7	70	158
QF100 9*	A	40	6"	3	4" NPT	94.0	43.3	50.7	5.4	5.7	70	220
QF100 10*	A	40	6"	3	4" NPT	98.4	43.3	55.2	5.4	5.7	75	220
QF100 11*	A	50	6"	3	4" NPT	104.5	44.9	59.6	5.4	5.7	81	361
QF100 12*	A	50	6"	3	4" NPT	108.9	44.9	64.0	5.4	5.7	82	361
QF100 13*	A	50	6"	3	4" NPT	113.3	44.9	68.4	5.4	5.7	93	361
QF100 14*	A	60	6"	3	4" NPT	121.3	48.4	72.9	5.4	7.1	98	416
QF100 15*	A	60	6"	3	4" NPT	125.7	48.4	77.3	7.5	7.1	103	416
QF100 16*	A	75	8"	3	4" NPT	135.7	52.8	82.9	7.5	7.1	107	447
QF100 17*	A	75	8"	3	4" NPT	140.1	52.8	87.4	7.5	7.1	112	447
QF100 18	A	75	8"	3	4" NPT	144.6	52.8	91.8	7.5	7.1	119	447

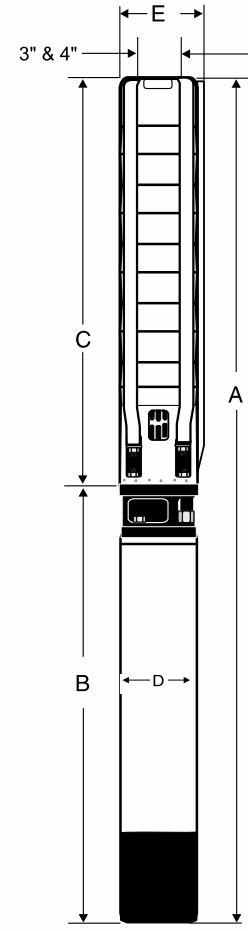

Fig. A

NOTES: Models 2-15 Stgs. are suitable for use in 6" wells, 16-18 Stgs. are suitable for use in 8" wells.

* Alternate motor sizes available.

PERFORMANCE CURVE

385 GPM

MODEL QF 125

FLOW RANGE: 75 - 550 GPM

OUTLET SIZE: 5" NPT

NOMINAL DIA. 8"

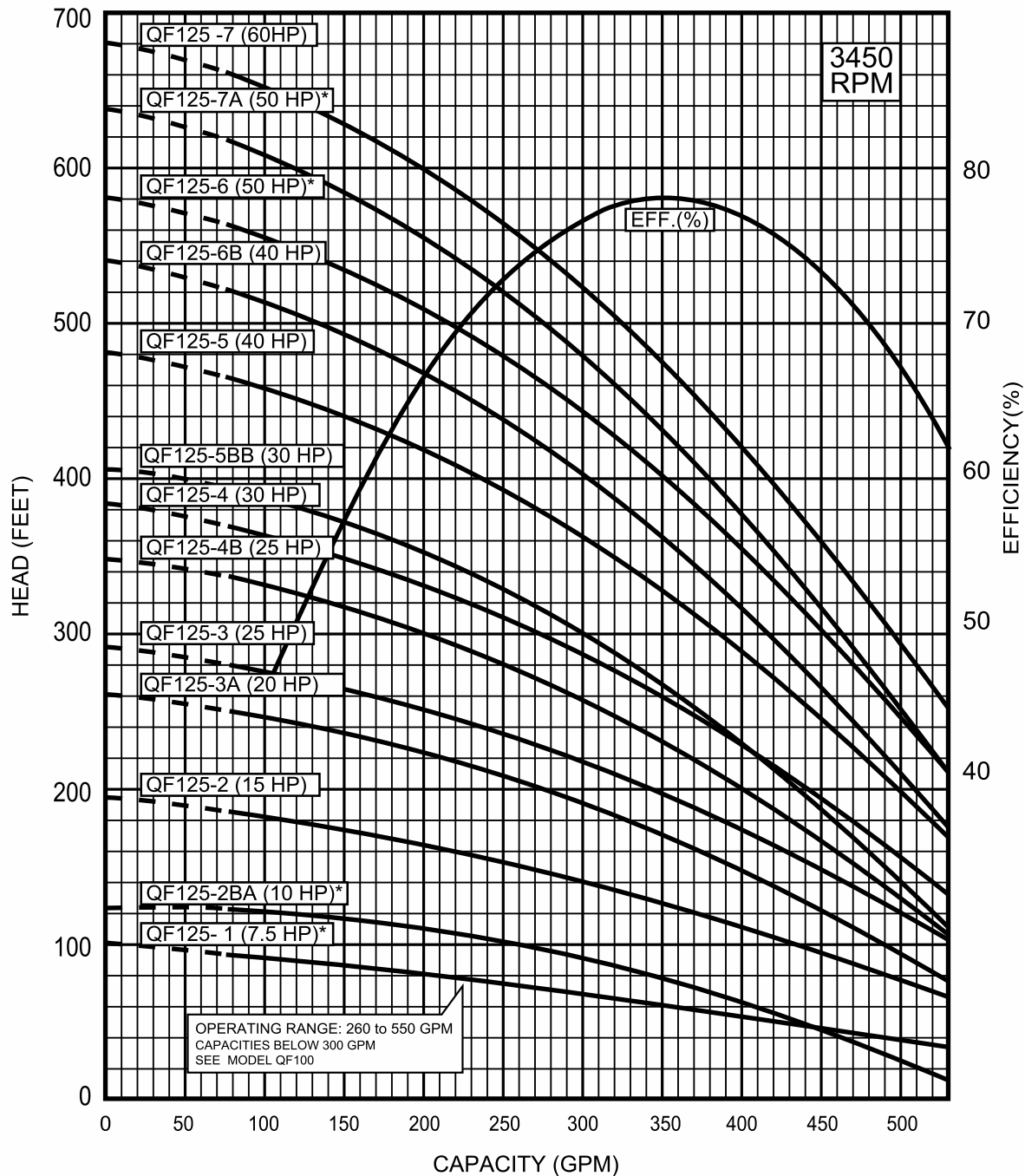

SPECIFICATIONS SUBJECT TO CHANGE WITHOUT NOTICE.
6" MOTOR STANDARD, 10-60 HP/3450 RPM.
8" MOTOR STANDARD, 75-100 HP/3525 RPM.
* Alternate motor sizes available.

Performance conforms to ISO 9906 Annex A
@ 8 ft. min. submergence.

PERFORMANCE CURVE

385 GPM

MODEL QF 125

FLOW RANGE: 75 - 550 GPM

OUTLET SIZE: 5" NPT

NOMINAL DIA. 8"

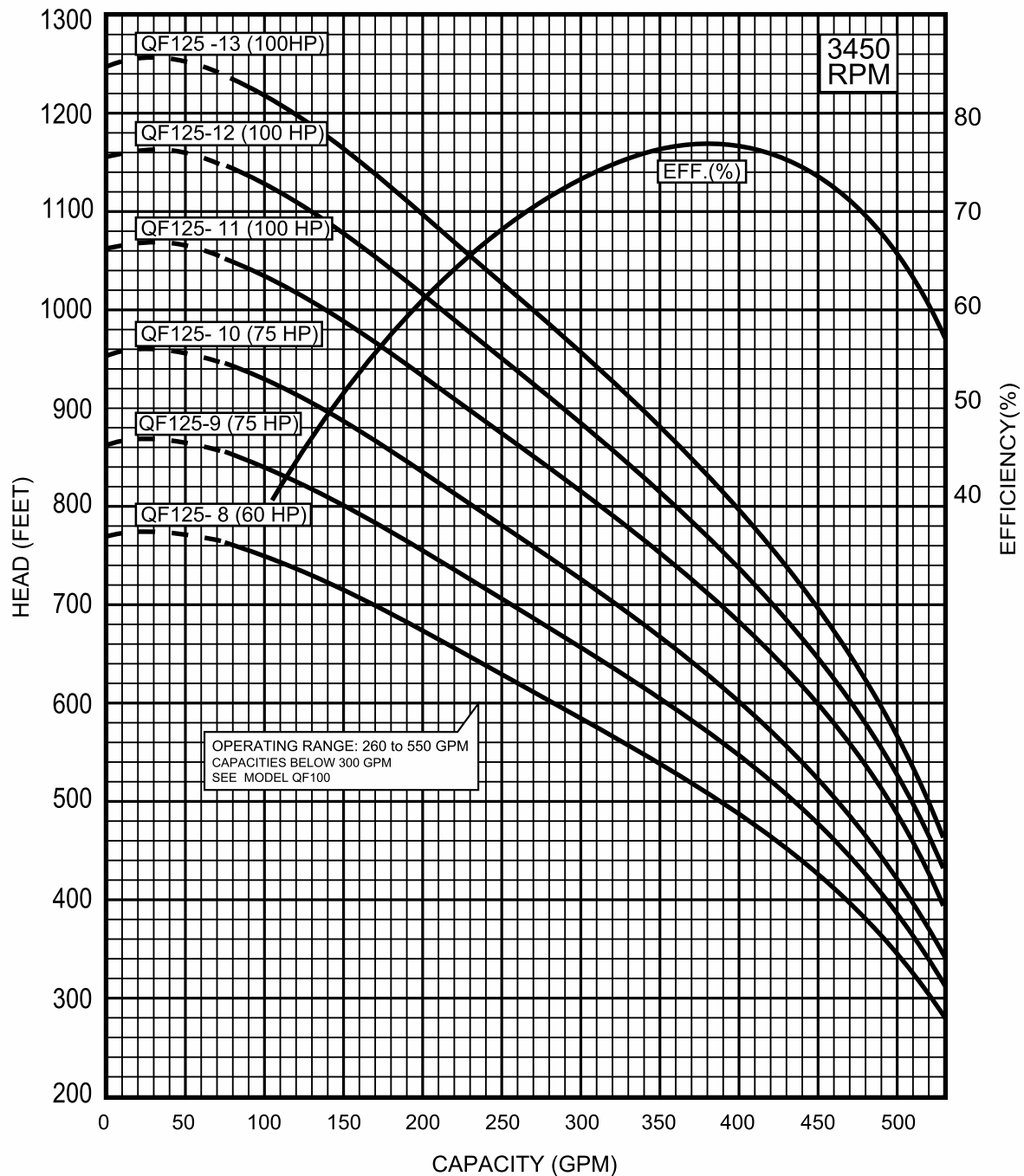

SPECIFICATIONS SUBJECT TO CHANGE WITHOUT NOTICE.
6" MOTOR STANDARD, 10-60 HP/3450 RPM.
8" MOTOR STANDARD, 75-100 HP/3525 RPM.
* Alternate motor sizes available.

Performance conforms to ISO 9906 Annex A
@ 8 ft. min. submergence.

TECHNICAL DATA

385 GPM

MODEL QF 125

DIMENSIONS AND WEIGHTS

MODEL NO.	FIG.	HP	MOTOR SIZE	DISCH. SIZE	DIMENSIONS IN INCHES					APPROX SHIPPING WEIGHT (lbs)	
					A	B	C	D	E	PUMP	MOTOR
QF125-1	A	7.5	6"	5" NPT	48.8	24.2	24.6	5.4	7.0	51	99
QF125-2BA	A	10	6"	5" NPT	55.1	25.5	29.6	5.4	7.0	59	108
QF125-2	A	15	6"	5" NPT	57.6	28.0	29.6	5.4	7.0	59	119
QF125-3A	A	20	6"	4" NPT	65.2	30.6	34.6	5.4	7.0	69	132
QF125-3	A	25	6"	5" NPT	67.8	33.1	34.6	5.4	7.0	69	145
QF125-4-B	A	25	6"	5" NPT	72.8	33.1	39.7	5.4	7.0	78	145
QF125-4	A	30	6"	5" NPT	75.4	35.7	39.7	5.4	7.0	86	158
QF125-5BB	A	30	6"	5" NPT	80.4	35.7	44.7	5.4	7.0	91	158
QF125-5*	A	40	6"	5" NPT	88.0	43.3	44.7	5.4	7.0	93	220
QF125-6B	A	40	6"	5" NPT	93.0	43.3	49.8	5.4	7.0	103	220
QF125-6*	A	50	6"	5" NPT	108.3	58.5	49.8	5.4	7.0	105	308
QF125-7A	A	50	6"	5" NPT	113.3	58.5	54.8	5.4	7.0	114	308
QF125-7*	A	60	6"	5" NPT	119.4	64.6	54.8	5.4	7.0	114	352
QF125-8*	A	60	6"	5" NPT	124.4	64.6	59.8	5.4	7.0	124	352
QF125-9	A	75	8"	5" NPT	118.2	52.8	65.5	7.6	7.7	144	447
QF125-10	A	75	8"	5" NPT	123.3	52.8	70.5	7.6	7.7	154	447
QF125-11	A	100	8"	5" NPT	137.0	61.4	75.6	7.6	7.7	164	642
QF125-12	A	100	8"	5" NPT	142.0	61.4	80.6	7.6	7.7	174	642
QF125-13	A	100	8"	5" NPT	149.7	64.1	85.6	7.6	7.7	185	642

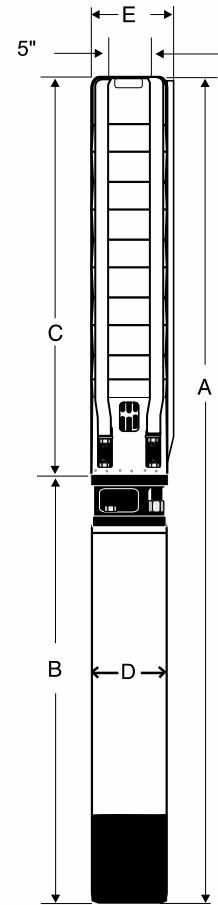

Fig. A

NOTES: All models suitable for use in 8" wells, unless otherwise noted.
 *Alternate motor sizes available.

PERFORMANCE CURVE

475 GPM

MODEL QF 160

FLOW RANGE: 95 - 680 GPM

OUTLET SIZE: 5" NPT

NOMINAL DIA. 8"

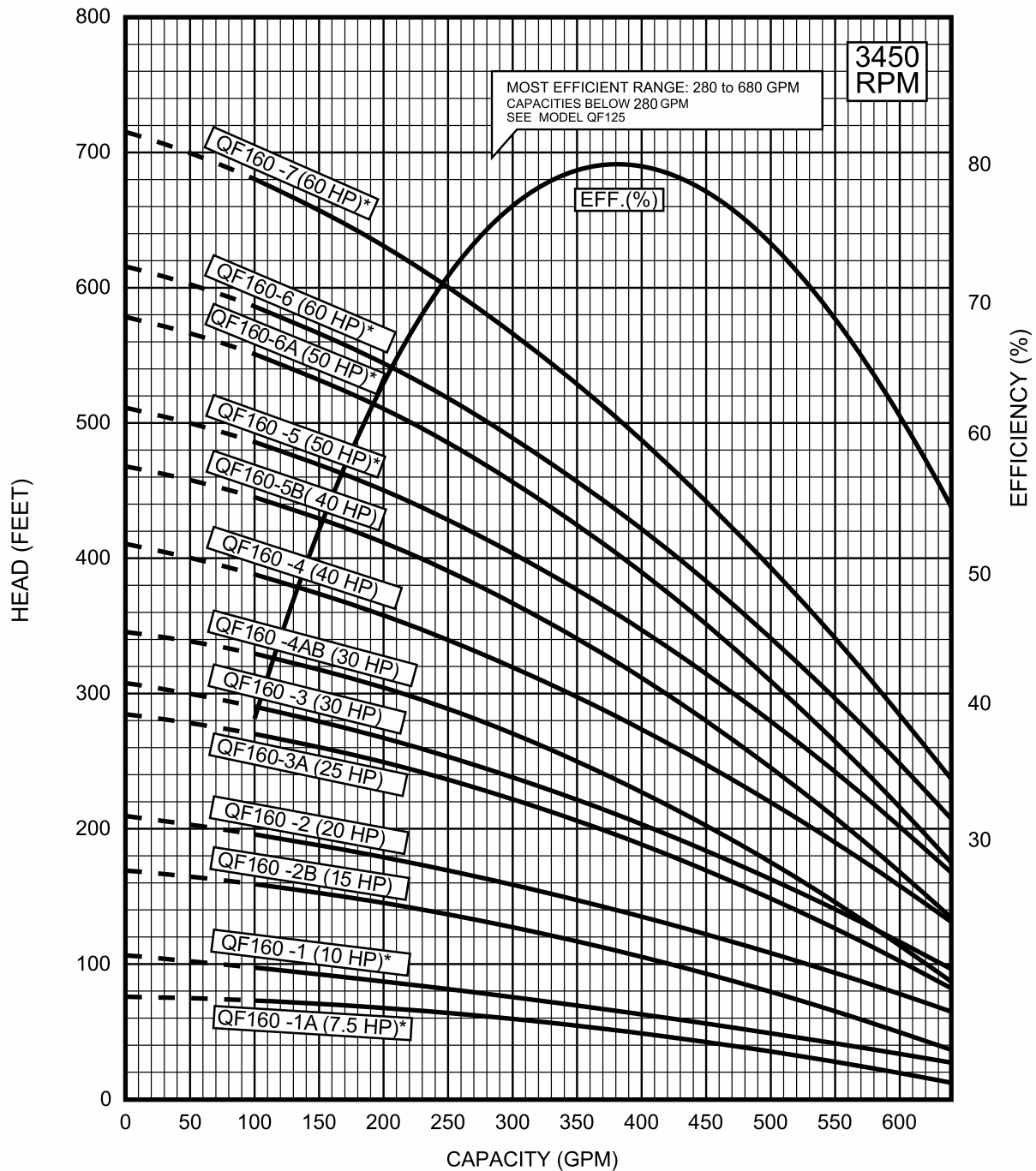

SPECIFICATIONS SUBJECT TO CHANGE WITHOUT NOTICE.

6" MOTOR STANDARD, 10-60 HP/3450 RPM.

8" MOTOR STANDARD, 75-125 HP/3525 RPM.

* Alternate motor sizes available.

Performance conforms to ISO 9906 Annex A

@ 8 ft. min. submergence.

PERFORMANCE CURVE

475 GPM

MODEL QF 160

FLOW RANGE: 95 - 680 GPM

OUTLET SIZE: 5" NPT

NOMINAL DIA. 8"

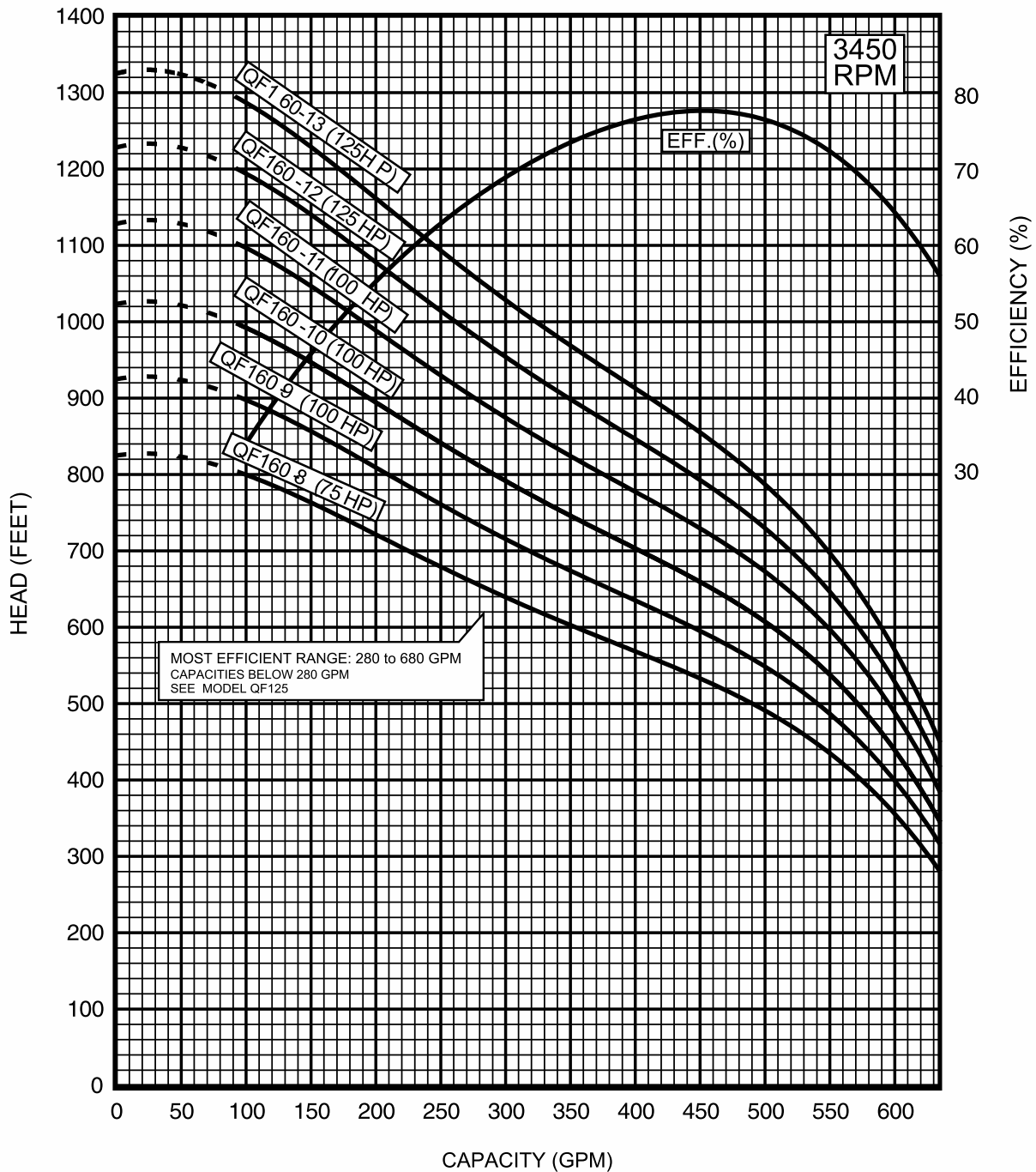

SPECIFICATIONS SUBJECT TO CHANGE WITHOUT NOTICE.

6" MOTOR STANDARD, 10-60 HP/3450 RPM.

8" MOTOR STANDARD, 75-125 HP/3525 RPM.

* Alternate motor sizes available.

Performance conforms to ISO 9906 Annex A
@ 8 ft. min. submergence.

TECHNICAL DATA

475 GPM

MODEL QF 160

DIMENSIONS AND WEIGHTS

MODEL NO.	FIG.	HP	MOTOR SIZE	DISCH. SIZE	DIMENSIONS IN INCHES					APPROX SHIPPING WEIGHT (lbs)	
					A	B	C	D	E	PUMP	MOTOR
QF160-1A	A	7.5	6"	5" NPT	48.8	24.2	24.6	5.4	7.0	51	99
QF160-1	A	10	6"	5" NPT	50.0	25.5	24.6	5.4	7.0	51	108
QF160-2B	A	15	6"	5" NPT	57.6	28.0	29.6	5.4	7.0	59	119
QF160-2	A	20	6"	5" NPT	60.2	30.6	29.6	5.4	7.0	59	132
QF160-3A	A	25	6"	5" NPT	67.8	33.1	34.6	5.4	7.0	69	145
QF160-3	A	30	6"	5" NPT	70.3	35.7	34.6	5.4	7.0	69	158
QF160-4AB	A	30	6"	5" NPT	75.4	35.7	39.7	5.4	7.0	78	158
QF160-4*	A	40	6"	5" NPT	82.9	43.3	39.7	5.4	7.0	78	220
QF160-5B	A	40	6"	5" NPT	88.0	43.3	44.7	5.4	7.0	90	220
QF160-5*	A	50	6"	5" NPT	103.3	58.5	44.7	5.4	7.0	90	308
QF160-6A*	A	50	6"	5" NPT	108.3	58.5	49.8	5.4	7.0	103	308
QF160-6*	A	60	8"	5" NPT	146.8	48.4	98.3	7.6	7.7	116	416
QF160-7*	A	60	8"	5" NPT	154.7	48.4	106.3	7.6	7.7	126	416
QF160-8	A	75	8"	5" NPT	166.9	52.8	114.2	7.6	7.7	136	447
QF160-9	A	100	8"	5" NPT	183.5	61.4	122.1	7.6	7.7	144	642
QF160-10	A	100	8"	5" NPT	191.4	61.4	130.0	7.6	7.7	154	642
QF160-11	A	100	8"	5" NPT	199.3	61.4	137.9	7.6	7.7	164	642
QF160-12	A	125	8"	5" NPT	214.4	68.5	145.9	7.6	7.7	174	642
QF160-13	A	125	8"	5" NPT	222.3	68.5	153.8	7.6	7.7	185	642
Pipe Adapter	A										

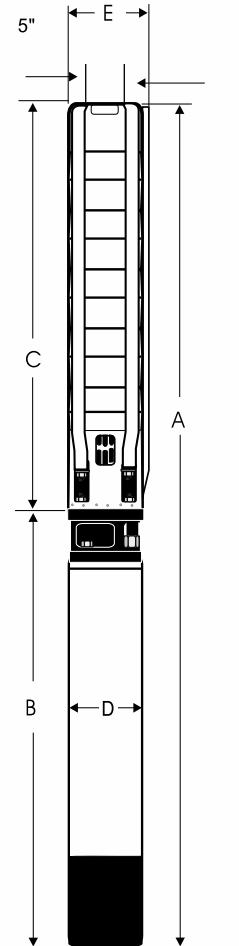

NOTES: All models suitable for use in 8" wells, unless otherwise noted.

*Alternate motors sizes available.

PERFORMANCE CURVE

625 GPM

MODEL QF 210

FLOW RANGE: 125 - 850 GPM OUTLET SIZE: 6" NPT NOMINAL DIA. 10"

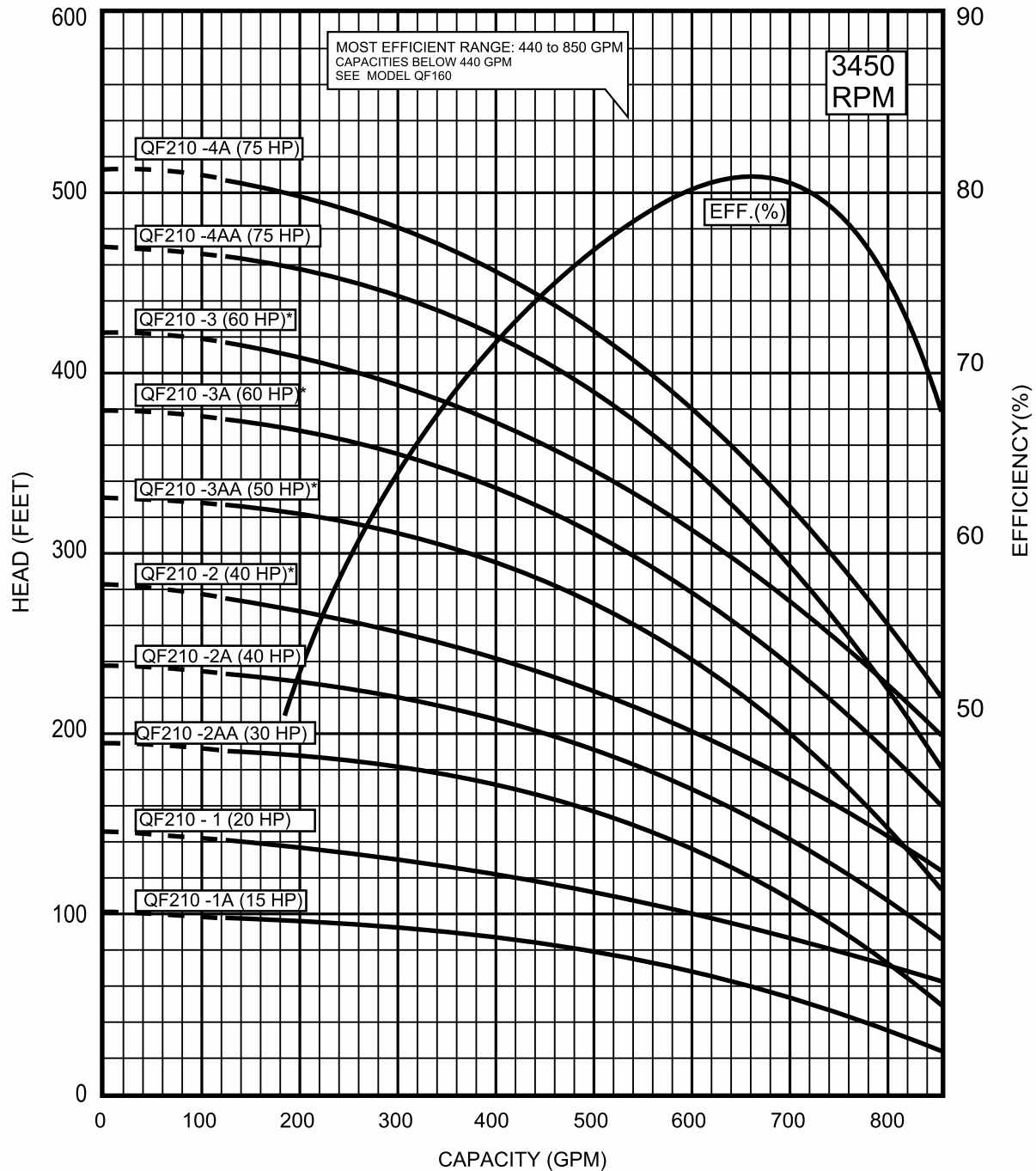

SPECIFICATIONS SUBJECT TO CHANGE WITHOUT NOTICE.
 6" MOTOR STANDARD, 15-60 HP/3450 RPM.
 8" MOTOR STANDARD, 75-150 HP/3525 RPM.
 * Alternate motor sizes available.

Performance conforms to ISO 9906 Annex A
 @ 10 ft. min. submergence.

PERFORMANCE CURVE

625 GPM

MODEL QF 210

FLOW RANGE: 125 - 850 GPM OUTLET SIZE: 6" NPT NOMINAL DIA. 10"

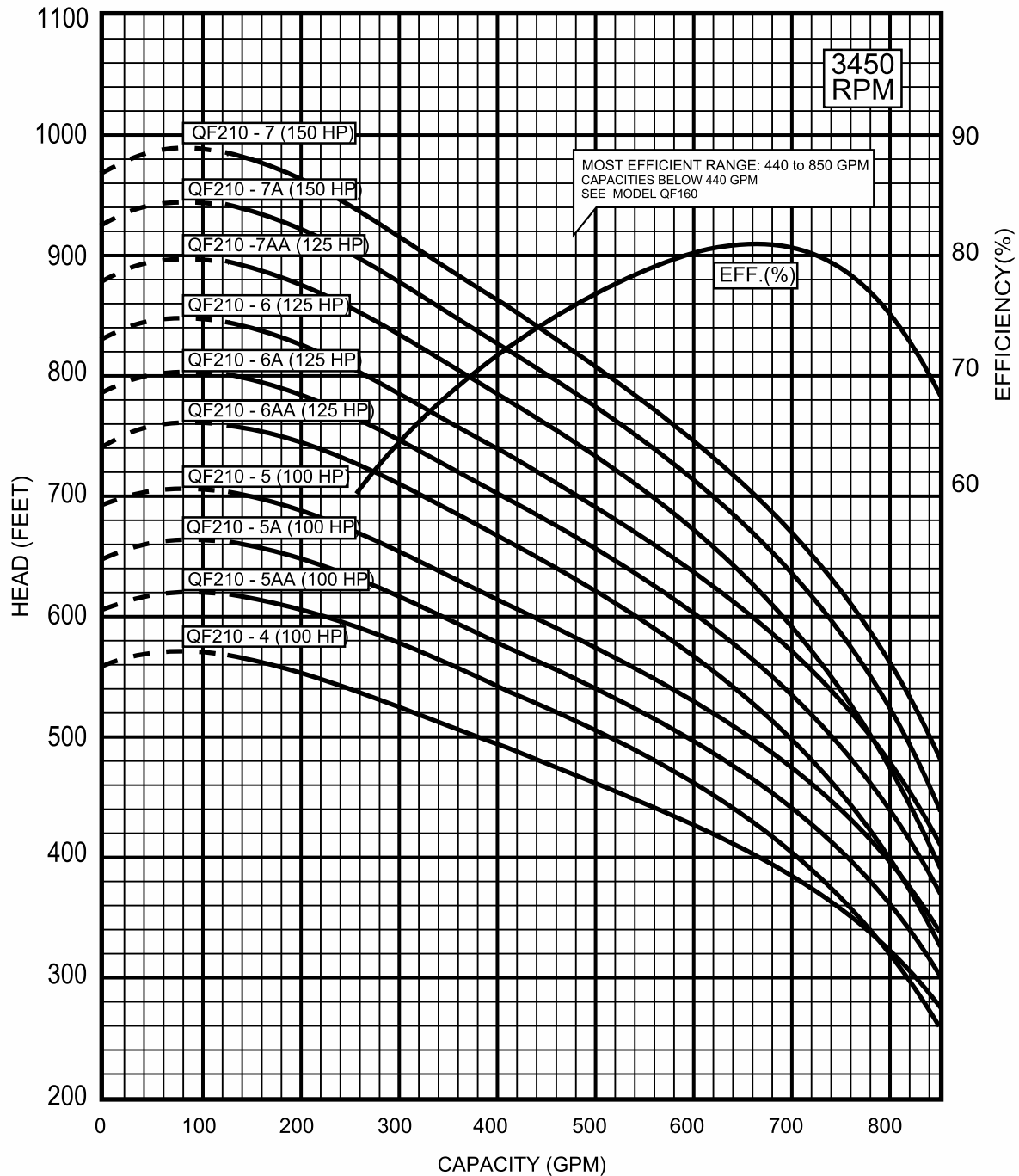

SPECIFICATIONS SUBJECT TO CHANGE WITHOUT NOTICE.
6" MOTOR STANDARD, 15-60 HP/3450 RPM.
8" MOTOR STANDARD, 75-150 HP/3525 RPM.
* Alternate motor sizes available.

Performance conforms to ISO 9906 Annex A
@ 10 ft. min. submergence.

TECHNICAL DATA

625 GPM

MODEL QF 210

DIMENSIONS AND WEIGHTS

MODEL NO.	FIG.	HP	MOTOR SIZE	DISCH. SIZE	DIMENSIONS IN INCHES					APPROX SHIPPING WEIGHT (lbs)	
					A	B	C	D	E	PUMP	MOTOR
QF210-1A	A	15	6"	6" NPT	53.5	28.0	25.5	5.4	8.3	64	119
QF210-1	A	20	6"	6" NPT	56.1	30.6	25.5	5.4	8.3	64	132
QF210-2AA	A	30	6"	6" NPT	67.4	35.7	31.7	5.4	8.3	78	158
QF210-2A	A	40	6"	6" NPT	74.9	43.3	31.7	5.4	8.3	78	220
QF210-2*	A	50	6"	6" NPT	90.2	58.5	31.7	5.4	8.3	78	308
QF210-3AA*	A	50	6"	6" NPT	96.3	58.5	37.8	5.4	8.6	91	308
QF210-3A*	A	60	8"	6" NPT	86.0	48.4	37.6	5.4	8.6	91	416
QF210-3*	A	75	8"	6" NPT	90.3	52.8	37.6	5.4	8.6	91	447
QF210-4-AA	A	75	8"	6" NPT	96.5	52.8	43.7	7.6	8.6	105	447
QF210-4-A	A	100	8"	6" NPT	105.1	61.4	43.7	7.6	8.6	105	642
QF210-4	A	100	8"	6" NPT	105.1	61.4	43.7	7.6	8.6	105	642
QF210-5-AA	A	100	8"	6" NPT	111.2	61.4	49.8	7.6	8.6	119	642
QF210-5-A	A	100	8"	6" NPT	111.2	61.4	49.8	7.6	8.6	119	642
QF210-5	A	100	8"	6" NPT	111.2	61.4	49.8	7.6	8.6	119	642
QF210-6-AA	A	125	8"	6" NPT	124.5	68.5	56.0	7.7	8.6	149	642
QF210-6-A	A	125	8"	6" NPT	124.5	68.5	56.0	7.7	8.6	149	642
QF210-6	A	125	8"	6" NPT	124.5	68.5	56.0	7.7	8.6	149	642
QF210-7-AA	A	125	8"	6" NPT	130.6	68.5	62.1	7.7	8.6	165	642
QF210-7-A	A	150	8"	6" NPT	122.2	60.1	62.1	7.7	8.6	165	739
QF210-7	A	150	8"	6" NPT	122.2	60.1	62.1	7.7	8.6	165	739

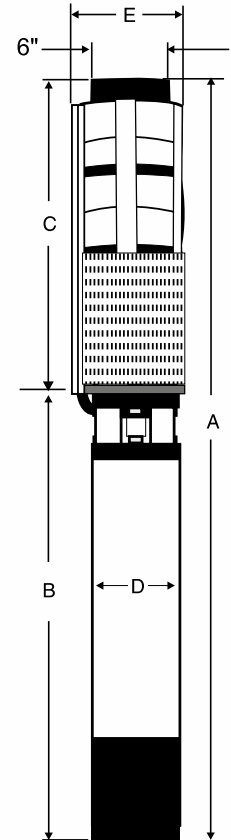

Fig. A

NOTES: All models suitable for use in 8" wells unless otherwise noted.
*Alternate motor sizes available.

PERFORMANCE CURVE

800 GPM

MODEL QF 270

FLOW RANGE: 220 -1400 GPM OUTLET SIZE: 6 " NPT NOMINAL DIA. 10"

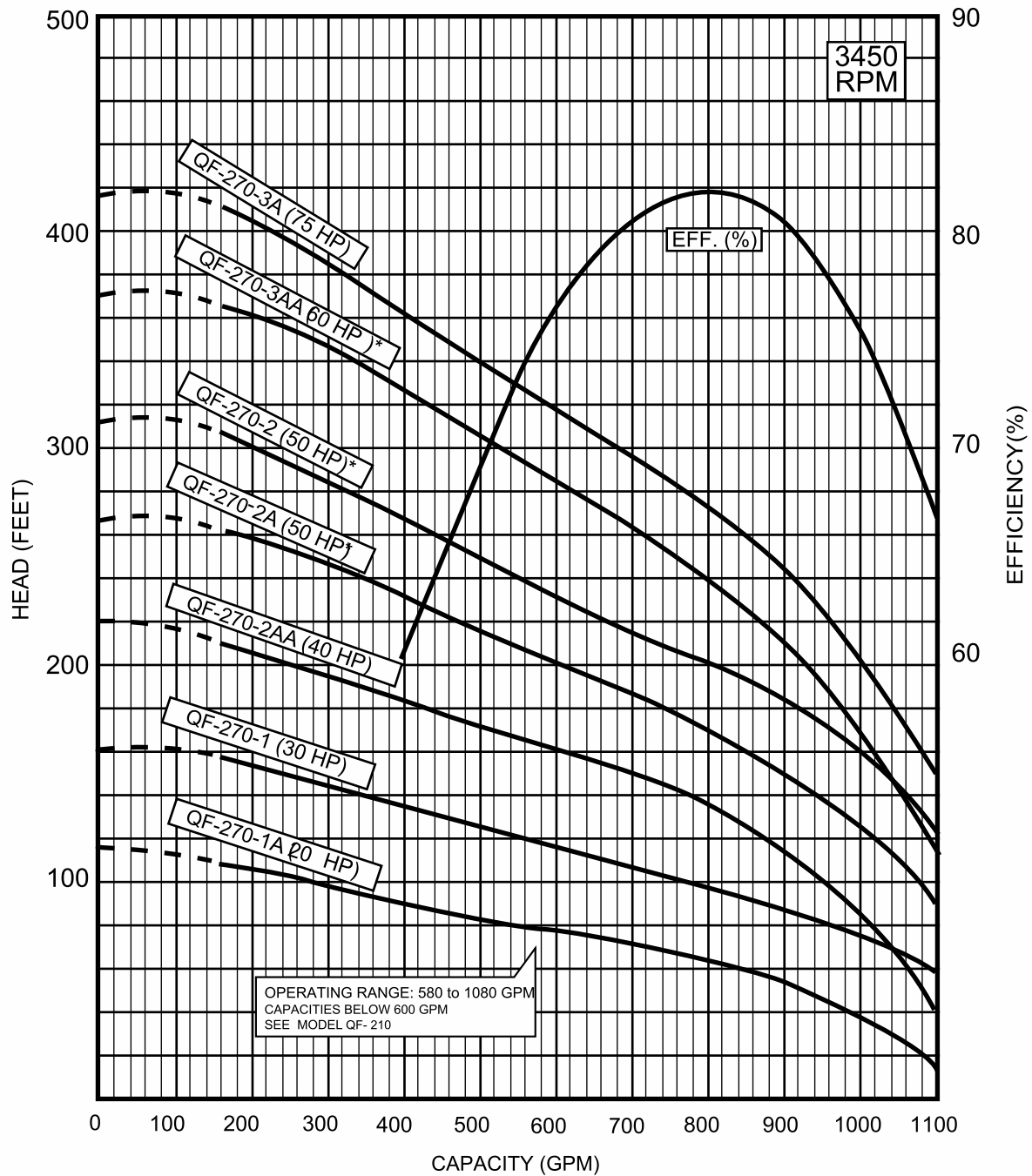

SPECIFICATIONS SUBJECT TO CHANGE WITHOUT NOTICE.
6" MOTOR STANDARD, 40 HP/3450 RPM.
8" MOTOR STANDARD, 60-200 HP/3525 RPM.
10" MOTOR STANDARD, 250 HP/3500 RPM.
* Alternate motor sizes available.

Performance conforms to ISO 9906 Annex A
@ 10 ft. min. submergence.

PERFORMANCE CURVE

800 GPM

MODEL QF 270

FLOW RANGE: 220 -1400 GPM OUTLET SIZE: 6 " NPT NOMINAL DIA. 10"

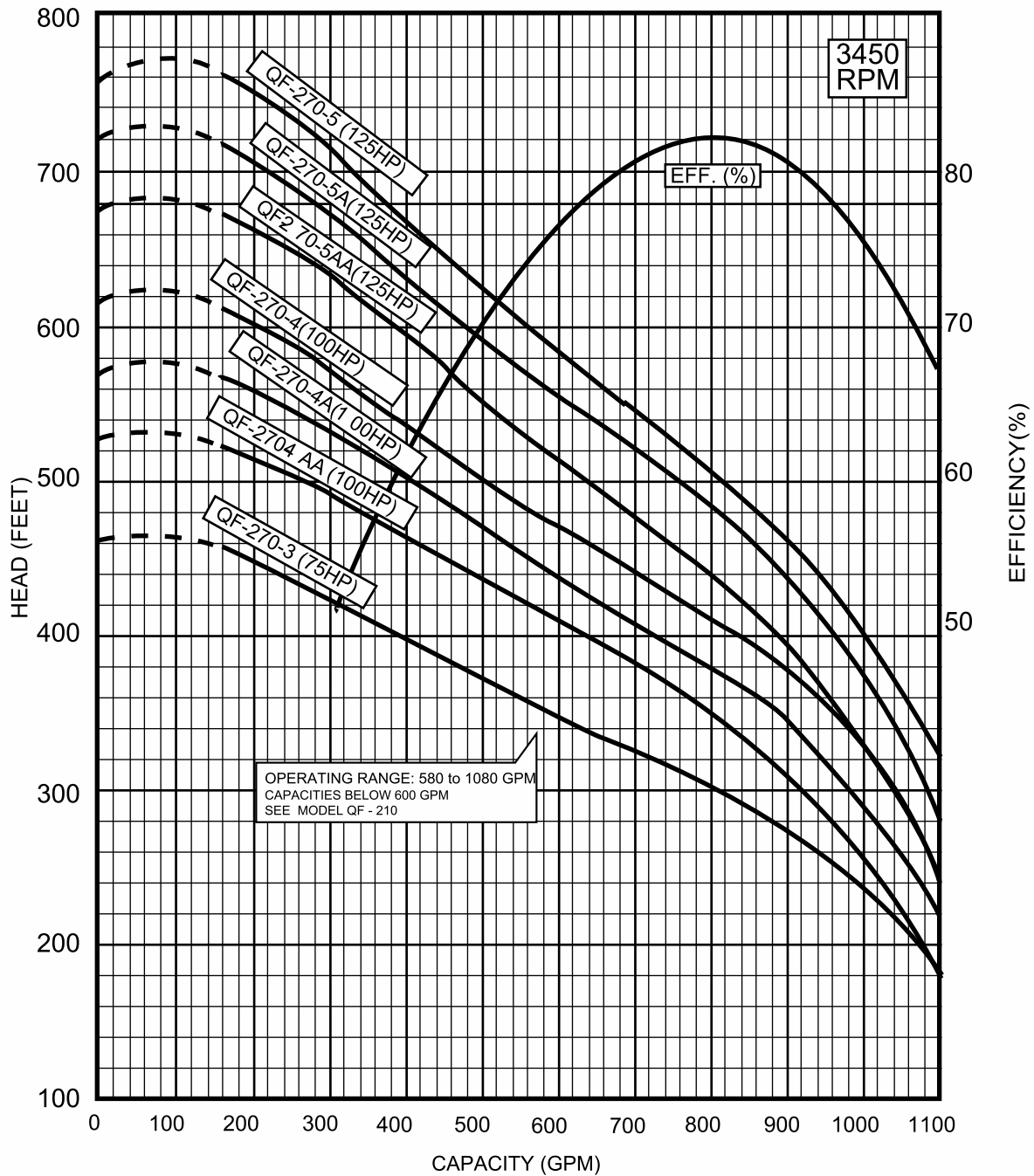

SPECIFICATIONS SUBJECT TO CHANGE WITHOUT NOTICE.
 6" MOTOR STANDARD, 40 HP/3450 RPM.
 8" MOTOR STANDARD, 60-200 HP/3525 RPM.
 10" MOTOR STANDARD, 250 HP/3500 RPM.
 * Alternate motor sizes available.

Performance conforms to ISO 9906 Annex A
 @ 10 ft. min. submergence.

TECHNICAL DATA

800 GPM

MODEL QF 270

DIMENSIONS AND WEIGHTS

MODEL NO.	FIG.	HP	MOTOR SIZE	DISCH. SIZE	DIMENSIONS IN INCHES					APPROX SHIPPING WEIGHT (lbs)	
					A	B	C	D	E	PUMP	MOTOR
QF270-1A	A	20	6"	6" NPT	56.1	30.6	25.5	5.4	8.3	64	132
QF270-1	A	30	6"	6" NPT	61.2	35.7	25.5	5.4	8.3	64	158
QF270-2AA*	A	40	6"	6" NPT	74.9	43.3	31.7	5.4	8.3	78	220
QF270-2A*	A	50	6"	6" NPT	90.2	58.5	31.7	5.4	8.3	78	308
QF270-2*	A	50	6"	6" NPT	90.2	58.5	31.7	5.4	8.3	78	308
QF270-2AA*	A	40	8"	6" NPT	76.3	44.9	31.4	7.6	8.6	78	361
QF270-2A*	A	50	8"	6" NPT	76.3	44.9	31.4	7.6	8.6	78	361
QF270-2*	A	50	8"	6" NPT	76.3	44.9	31.4	7.6	8.6	78	361
QF270-3AA*	A	60	8"	6" NPT	86.0	48.4	37.6	7.6	8.6	91	416
QF270-3A	A	75	8"	6" NPT	90.3	52.8	37.6	7.6	8.6	91	447
QF270-3	A	75	8"	6" NPT	90.3	52.8	37.6	7.6	8.6	91	447
QF270-4-AA	A	100	8"	6" NPT	105.1	61.4	43.7	7.6	8.6	105	642
QF270-4-A	A	100	8"	6" NPT	105.1	61.4	43.7	7.6	8.6	105	642
QF270-4	A	100	8"	6" NPT	105.1	61.4	43.7	7.6	8.6	105	642
QF270-5-AA	A	125	8"	6" NPT	115.3	65.5	49.8	7.6	8.6	119	642
QF270-5-A	A	125	8"	6" NPT	115.3	65.5	49.8	7.7	8.6	119	642
QF270-5	A	125	8"	6" NPT	115.3	65.5	49.8	7.7	8.6	119	642

NOTES: All models suitable for use in 10" wells, unless equipped with 10" motor.

* Alternate motor sizes available.

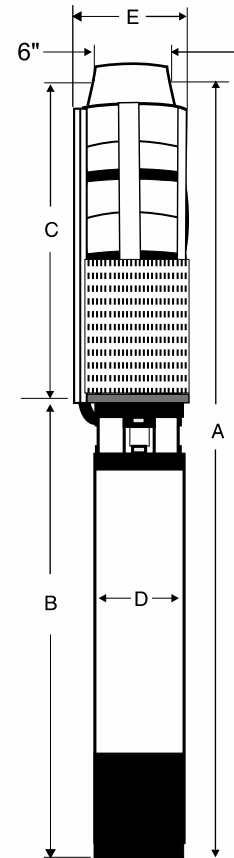

Fig. A

PERFORMANCE CURVE

1100 GPM

MODEL QF 360

FLOW RANGE: 220 -1400 GPM OUTLET SIZE: 6 " NPT NOMINAL DIA. 10"

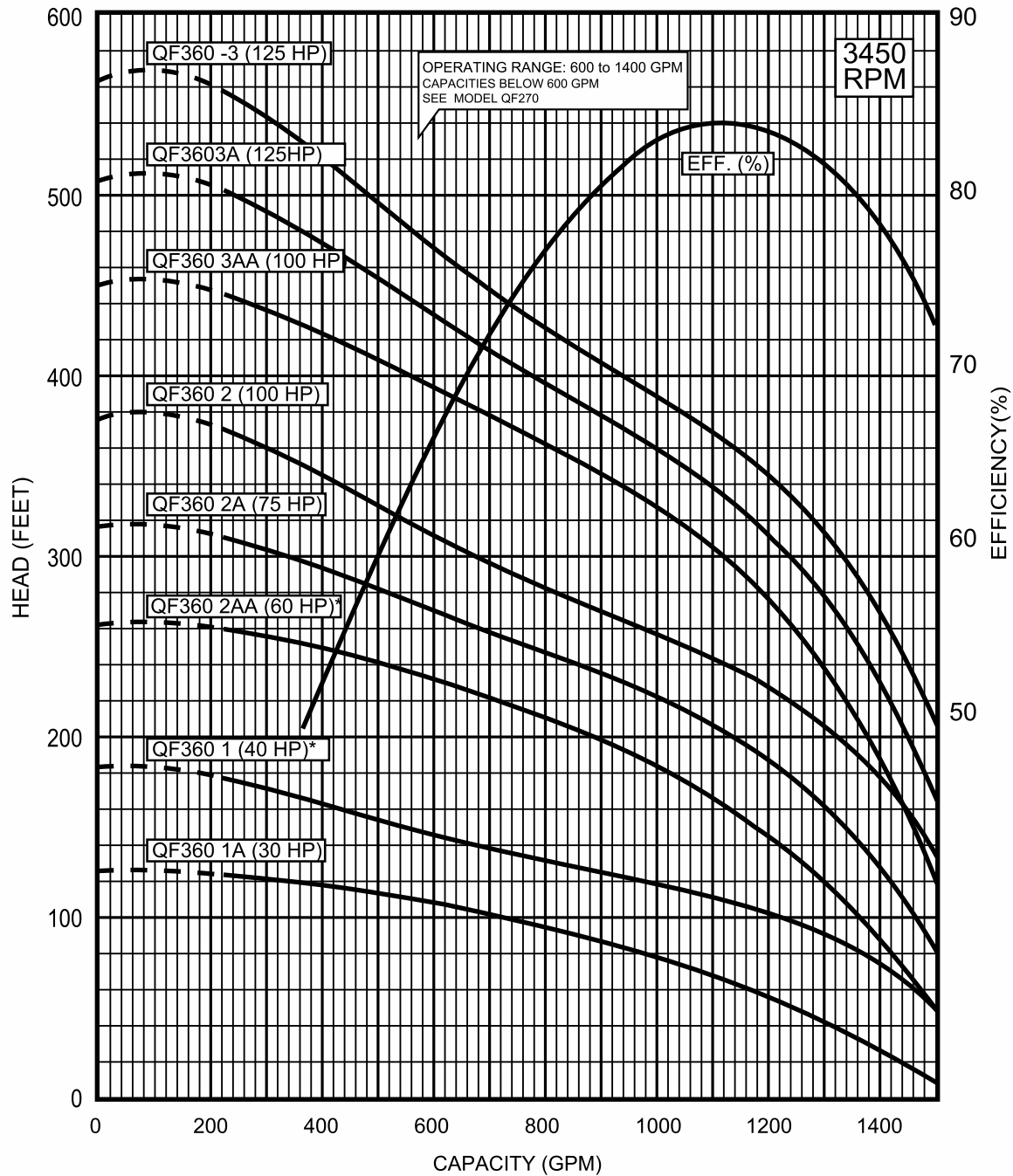

SPECIFICATIONS SUBJECT TO CHANGE WITHOUT NOTICE.
6" MOTOR STANDARD, 40 HP/3450 RPM.
8" MOTOR STANDARD, 60-200 HP/3525 RPM.
10" MOTOR STANDARD, 250 HP/3500 RPM.
* Alternate motor sizes available.

Performance conforms to ISO 9906 Annex A
@ 10 ft. min. submergence.

PERFORMANCE CURVE

1100 GPM

MODEL QF 360

FLOW RANGE: 220 -1400 GPM OUTLET SIZE: 6 " NPT NOMINAL DIA. 10"

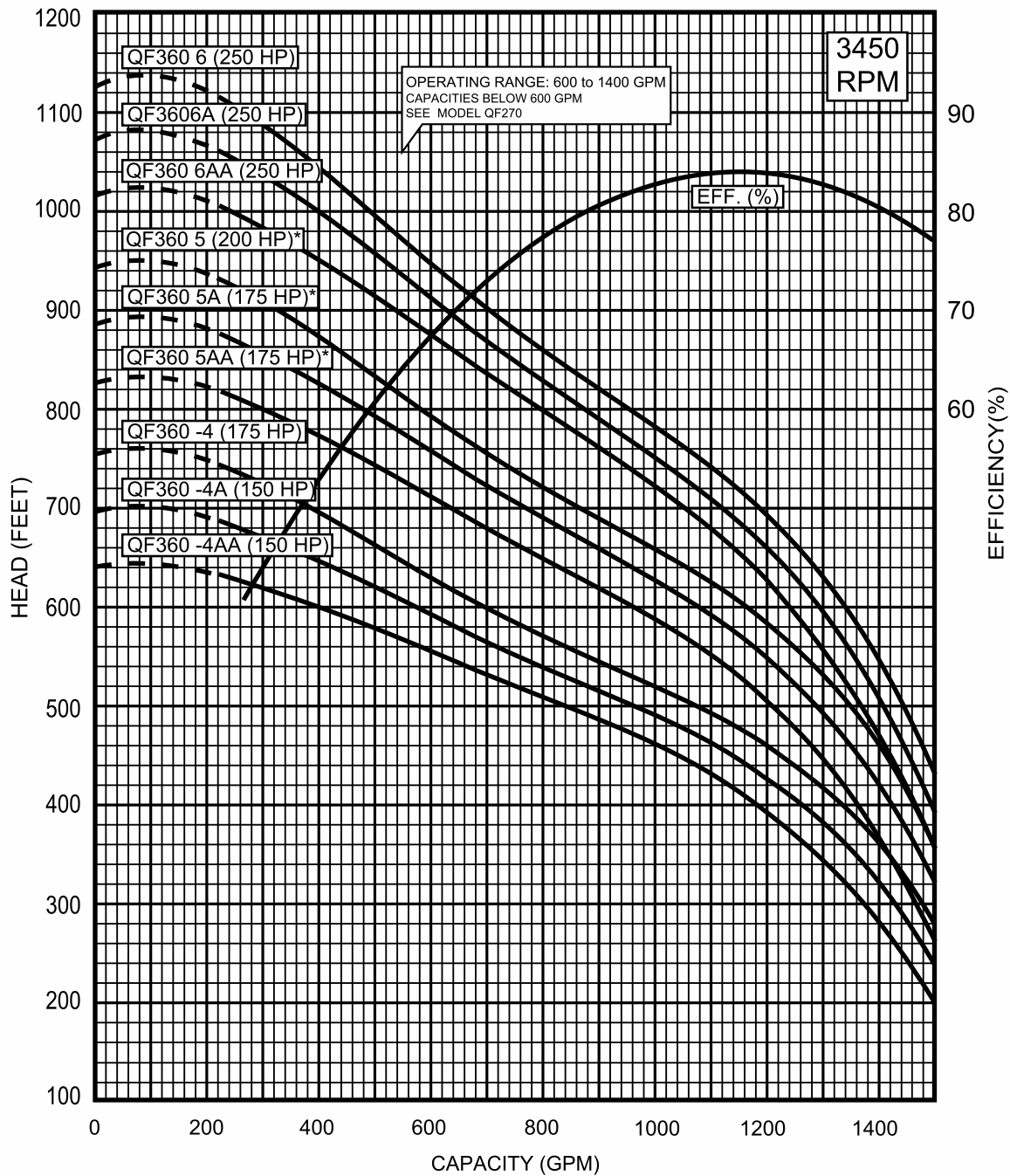

SPECIFICATIONS SUBJECT TO CHANGE WITHOUT NOTICE.
 6" MOTOR STANDARD, 40 HP/3450 RPM.
 8" MOTOR STANDARD, 60-200 HP/3525 RPM.
 10" MOTOR STANDARD, 250 HP/3500 RPM.
 * Alternate motor sizes available.

Performance conforms to ISO 9906 Annex A
 @ 10 ft. min. submergence.

TECHNICAL DATA

1100 GPM

MODEL QF 360

DIMENSIONS AND WEIGHTS

MODEL NO.	FIG.	HP	MOTOR SIZE	DISCH. SIZE	DIMENSIONS IN INCHES					APPROX SHIPPING WEIGHT (lbs)	
					A	B	C	D	E	PUMP	MOTOR
QF360-1A	A	30	6"	6" NPT	64.4	35.7	28.7	5.4	9.7	114	158
QF360-1*	A	40	6"	6" NPT	72.0	43.3	28.7	5.4	9.7	114	220
QF360-2AA*	A	60	8"	6" NPT	86.7	48.4	38.3	5.4	9.7	157	416
QF360-2A	A	75	8"	6" NPT	91.0	52.8	38.3	7.6	9.7	157	447
QF360-2	A	100	8"	6" NPT	99.7	61.4	38.3	7.6	9.7	157	642
QF360-3AA	A	100	8"	6" NPT	106.6	61.4	45.2	7.6	9.7	181	642
QF360-3A	A	125	8"	6" NPT	113.7	68.5	45.2	7.7	9.7	181	642
QF360-3	A	125	8"	6" NPT	113.7	68.5	45.2	7.7	9.7	181	642
QF360-4AA	A	150	10"	6" NPT	112.2	60.1	52.1	7.7	9.7	215	739
QF360-4A	A	150	10"	6" NPT	112.2	60.1	52.1	7.7	9.7	215	739
QF360-4	A	175	10"	6" NPT	117.4	65.3	52.1	7.7	9.7	215	906
QF360-5AA*	A	175	10"	6" NPT	124.4	65.3	59.1	7.7	9.7	237	906
QF360-5A*	A	175	10"	6" NPT	124.4	65.3	59.1	7.7	9.7	237	906
QF360-5*	A	200	10"	6" NPT	128.7	69.6	59.1	7.7	9.7	237	961
QF360-6AA	A	250	10"	6" NPT	141.5	75.6	66.0	9.1	10.9	268	1056
QF360-6A	A	250	10"	6" NPT	134.6	75.6	59.1	9.1	10.9	246	1056
QF360-6	A	250	10"	6" NPT	141.5	75.6	66.0	9.1	10.9	268	1056

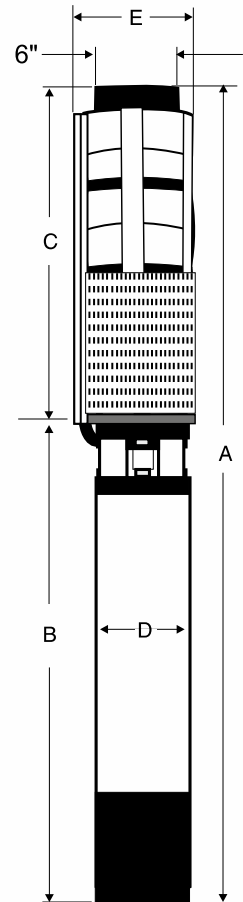

Fig. A

NOTES: All models suitable for use in 10" wells, unless equipped with 10" motor.
 * Alternate motor sizes available.

4" MOTOR PERFORMANCE DATA (SINGLE PHASE, 60HZ)

SINGLE PHASE MOTOR SPECIFICATION (60 HZ) 3450 RPM

RATING					FULL LOAD		MAXIMUM LOAD		WINDING (1) RES. IN OHMS	EFFICIENCY %		POWER FACTOR %		LOCKED ROTOR AMPS
[HP]	[KW]	VOLTS	HZ	S.F.	(2) AMPS	WATTS	(2) AMPS	WATTS	M= MAIN RES. S=START RES.	S.F.	F.I.	S.F.	F.I.	
0.5	0.37	230	60	1.6	Y= 3.5	720	Y=3.85	960	M 4.7-5.7	67	52	90	89	23
					B=4.0		B=4.40		S 9.4-11.6					
					R=2.1		R=2.31							
0.75	0.55	230	60	1.5	Y=6.7	1110	Y=7.37	1310	M 2.7-3.3	69	51	92	78	34.2
					B=5.8		B=6.38		S 7.2-8.8					
					R=2.6		R=2.86							
1.0	0.75	230	60	1.4	Y=7.3	1200	Y=8.03	1600	M 2.8-3.5	70	63	92	77	41.8
					B=4.9		B=5.39		S 5.9-7.26					
					R=2.3		R=2.53							
1.5	1.1	230	60	1.3h	Y=8.7	1740	Y=9.57	2080	M 1.9-2.4	70	65	85	87	51.4
					B=8.4		B=9.24		S 3.6-4.4					
					R=1.8		R=1.98							
2.0	1.5	230	60	1.25	Y=10.0	2025	Y=11.0	2555	M 1.8-2.3	73	68	95	99	53.1
					B=9.3		B=10.23		S 5.5-7.2					
					R=2.6		R=2.86							
3.0	2.2	230	60	1.15	Y=16.5	3560	Y=18.15	3400	M 1.1-1.4	75	63	99	94	83.4
					B=15.3		B=16.83		S 2.2-2.7					
					R=5.4		R=5.94							
5.0	3.7	230	60	1.15	Y=23.0	4830	Y=25.3	5500	M 0.71-0.82	78	77	100	98	129
					B=15.9		B=17.49		S 1.8-2.2					
					R=11.0		R=12.1							

- (1) Main winding - yellow to black
Start winding - yellow to red
- (2) Y= Yellow lead -line amps
B= Black lead - main winding amps
R= Red lead - start or auxillary winding amps.

4" MOTOR PERFORMANCE DATA (THREE PHASE, 60HZ)

THREE PHASE MOTOR SPECIFICATION (60 HZ) 3450 RPM

RATING					FULL LOAD		MAXIMUM LOAD		LINE TO LINE RESISTANCE IN OHMS	EFFICIENCY %		LOCKED ROTOR AMPS
[HP]	[KW]	VOLTS	HZ	S.F.	AMPS	WATTS	AMPS	WATTS		S.F.	F.I.	
0.5	0.37	230	60	1.6	2.4	585	2.9	860	9.5-10.9	70	64	15.2
		380			1.4	585	2.1	860	23.2-28.6	70	64	9.2
		460			1.2	644	1.5	860	38.4-44.1	70	58	7.2
0.75	0.55	230	60	1.5	3.1	810	3.8	1150	6.8-7.8	73	69	21.4
		380			1.9	810	2.5	1150	16.6-20.3	73	69	13.0
		460			1.2	810	1.9	1150	27.2-30.9	73	66	10.7
1	0.75	230	60	1.4	3.9	1070	4.7	1440	4.9-5.6	72	70	26.9
		380			2.3	1070	2.8	1440	12.2-14.9	72	70	16.3
		460			2	1212	2.4	1440	19.9-23.0	72	63	13.5
1.5	1.1	230	60	1.3	5	1460	5.9	1890	3.2-4.0	76	76	33.2
		380			3	1460	3.6	1890	8.5-10.4	76	76	20.1
		460			3	1760	3.1	1890	13-16	76	65	16.6
2	1.5	230	60	1.25	6.7	1960	8.1	2430	2.3-3	76	76	45
		380			4.1	1960	4.9	2430	6.6-8.2	76	76	26.6
		460			4.1	2304	4.1	2430	9.2-12	76	67	22.5
3	2.2	230	60	1.15	9.5	2920	10.9	3360	1.8-2.2	77	77	60.3
		380			5.8	2920	6.6	3360	4.7-6	77	77	37.5
		460			5.3	3120	5.5	3360	7.2-8.8	77	71	31
5	3.7	230	60	1.15	15.9	4800	17.8	5500	0.91-1.1	78	78	102
		380			9.6	4800	10.8	5500	2.6-3.2	78	78	60.2
		460			8.5	5240	8.9	5500	3.6-4.4	78	71	53.7
7.5	5.5	230	60	1.15	23	7150	26.4	8200	0.60-0.70	78	78	152
		380			13.9	7150	16	8200	1.6-2.0	78	78	92.7
		460			12.2	7540	13.2	8200	2.3-2.8	78	73	83.8
10	7.5	230	60	1.15	31.2	10500	34.6	11400	0.50-0.60	75	75	234
		380			19.3	10000	21	11400	1.2-1.6	75	75	140
		460			17	10120	17.3	11400	1.8-2.3	75	74	116

6" MOTOR PERFORMANCE DATA (THREE PHASE, 60HZ)

6 INCH REWINDABLE MOTORS PERFORMANCE DATA 60 HZ

RATING					FULL LOAD		MAXIMUM LOAD		LINE TO LINE RESISTANCE IN OHMS	EFFICIENCY %		LOCKED ROTOR AMPS
[HP]	[kW]	VOLTS	Hz	S.F.	AMPS	WATTS	AMPS	WATTS		S.F.	F.L.	
5.5	4	230	60	1.15	16.2	5183	18.3	5960	1-1.03	77	77	106
		380			8.8	4850	9.9	5578	2.86-2.95	78	78	61
		460			8.9	5160	10.1	5934	2.86-2.95	78	78	51
7.5	5.5	230	60	1.15	21.8	7200	24.6	8280	1-1.03	77	77	106
		380			12.2	6750	13.8	7763	2.86-2.95	77	77	61
		460			11	7000	12.4	8050	2.86-2.95	79	79	51
10	7.5	230	60	1.15	29.5	9650	33.3	11098	0.6-0.63	78	78	146
		380			16.7	9220	18.9	10603	1.86-1.75	79	79	81
		460			16.6	9720	18.8	11178	1.86-1.75	78	78	64
12.5	9.3	230	60	1.15	36.5	12012	41.2	13814	0.51-0.54	78	78	183
		380			20.1	11318	22.7	13016	1.52-1.6	80	80	100
		460			19.1	11750	21.6	13513	1.52-1.6	79	79	78
15	11	230	60	1.15	44.1	14126	49.8	16245	0.44-0.46	78	78	220
		380			24.2	13410	27.3	15422	1.3-1.34	80	80	129
		460			22.9	13860	25.9	15939	1.3-1.34	80	80	98
17.5	13	230	60	1.15	51.2	16832	57.9	19357	0.39-0.40	77	77	288
		380			27.7	15564	31.3	17899	1.16-1.18	79	79	164
		460			25.1	16102	28.4	18517	1.16-1.18	81	81	125
20	15	230	60	1.15	57.1	18714	64.5	21521	0.29-0.30	81	81	325
		380			31.6	17842	35.7	20518	0.81-0.84	82	82	188
		460			29.6	18280	33.4	21022	0.81-0.84	82	82	151
25	18.5	230	60	1.15	68.8	22712	77.7	26119	0.21-0.22	82	82	402
		380			39.3	22019	44.4	25322	0.65-0.67	81	81	249
		460			39.1	23441	44.2	26957	0.65-0.67	79	79	184
30	22	230	60	1.15	81.2	27382	91.8	31489	0.18-0.19	81	81	520
		380			47.6	27012	53.8	31064	0.57-0.58	79	79	309
		460			46.5	27926	52.5	32115	0.57-0.58	79	79	232
35	26	230	60	1.15	95.2	32546	107.6	37428	0.19-0.20	80	80	118.3
		380			55.1	31832	62.3	36607	0.56-0.57	79	79	67.5
		460			55.1	32615	62.3	37507	0.56-0.57	80	80	55.7
40	30	230	60	1.15	108	37412	122	43024	0.17-0.18	80	80	758
		380			64.6	36951	73	42494	0.52-0.54	79	79	436
		460			58.5	37312	66.1	42909	0.52-0.54	81	81	346
50	37	230	60	1.15	139	46950	157.1	53993	0.14-0.15	79	79	937
		380			78.5	44827	88.7	51551	0.43-0.44	78	78	567
		460			70.8	46085	80	52998	0.43-0.44	80	80	430



Sep/2017-18/L4/1000 VC - 2344 | Sep 2017/RO | SAP No. 29000000119

SHAKTI PUMPS USA LLC.

740, Florida Central Parkway, Suite # 1008, Longwood, FL 32750, USA
Ph: 407 574 4001, 407 574 2797,
E-mail : usa@shaktipumps.com, Visit us at : www.shaktipumps.us